

MINI-COOL BOLLARD H. 220mm

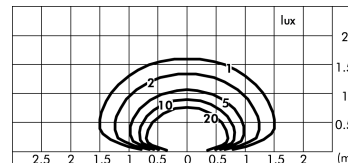
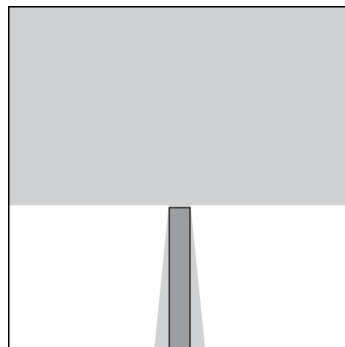
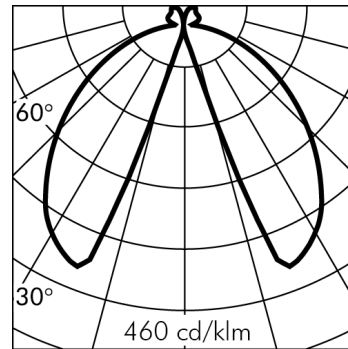
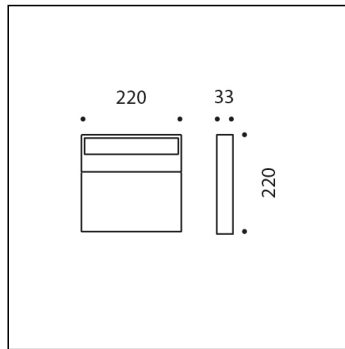
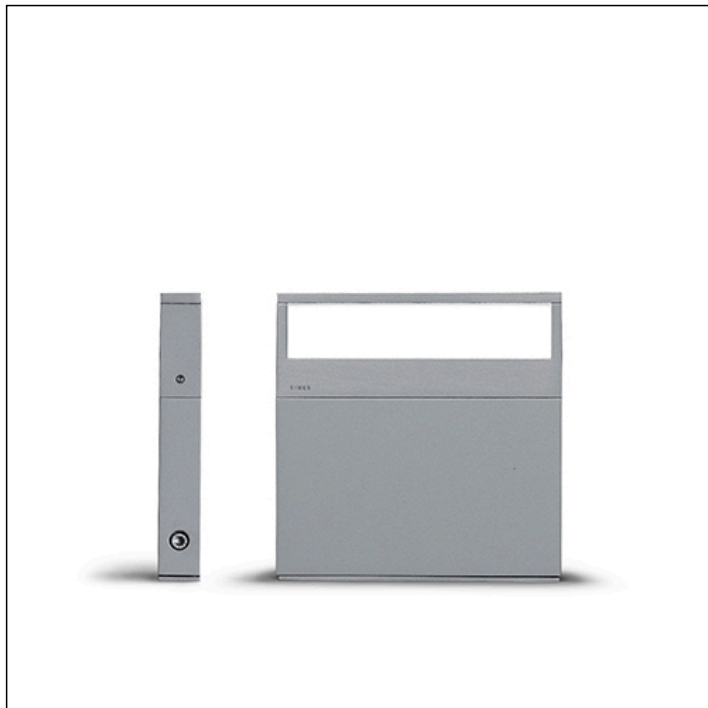

*Photometric measured using WHITE LED 3000K

Version is available on request.

S.7236N.14 (Aluminium grey)

module LED 4000K 220-240Vac ON-OFF
Garden bollard



Light Source Technical Data

Light source type:	LED
Colour temperature:	4000K
Rated module luminous flux:	1349lm
Rated luminaire luminous flux:	908lm
Rated module power:	6.6W
Rated luminaire power:	8.6W
Luminaire efficacy:	106lm/W
ULR:	25%
BUG:	B0 - U3 - G1
CIE Flux Code:	33 72 93 75 100
Color Rendering Index:	CRI 80
Standard Deviation Color Matching:	MacAdam step 3

Power Supply Technical Data

Voltage (AC):	220-240Vac
Frequency (AC):	50/60Hz
Voltage (DC):	176-264Vdc
Dimmable:	NOT DIMMABLE (ON-OFF)
Inrush Current:	27A 250µsec
Max. quantity of fixtures for Minature Circuit Breaker type B16A:	27
Max. quantity of fixtures for Minature Circuit Breaker type C16A:	45
Surge protection (between L-N):	1÷2kV
Surge protection (between L/N-PE):	2kV

Temperature and life time Technical Data

LED Lifetime:	L80 B10 70.000h Ta 25°C L80 B10 50.000h Ta 40°C
Lifespan of the LUMINAIRE:	min. 70.000h Ta 25°C min. 50.000h Ta 40°C
Performance ambient temperature:	Tq 25°C
Operating ambient temperature range:	da -20°C a +50°C
Storage temperature range:	da -20°C a +60°C

Technical Installation Data

Electrical insulation class:	II
Protection class IP:	IP54
Mechanical resistance:	IK06
Weight:	2.0583Kg
Power cable:	1m - H05RN-F

SPECIAL VERSION ON REQUEST: this Luminaires can be supplied with a surcharge in class III (without power supply). Requires working remote power supply in costant current at 500mA V_{fmin}=18.2Vdc V_{fmax}=23.8Vdc. Example SIMES compatible power supplies (check the complete list of the drivers on the catalogue):
Art. S.2438 POWER SUPPLY 230V/250mA-700mA 20W o 230Vac/24Vdc 16W 240Hz DALI DIMMABLE IN BOX IP67
Art. S.3426 POWER SUPPLY DALI MULTI-POWER 230V/250mA-700mA o 230V/24V 16W 240Hz IP20
NB: Use 1 Power Supply for each Luminaires

S.7236N.14 REV: B

Exclusive distributor for Ireland

Bushell Interiors Ltd - 12 Heaney Ave, Park West - Dublin 12 IRELAND - Tel.: +353 1 6710044 - e-mail: info@bushellinteriors.com

The present technical data sheet and all the information contained is property of SIMES S.p.A. All rights reserved.

We reserve the right to change specifications without prior written notice.

Last update 27/08/2024 - Pag. 1/3

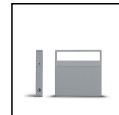
MINI-COOL BOLLARD H. 220mm
S.7236N.14 (Aluminium grey)**SPECS SHEET****LUMINAIRE TYPE**

Bollard fitting. IP rating IP 54

MATERIAL CHARACTERISTICS

Aluminium die cast housing in EN AB-47100 (low copper content) with high resistance against corrosion. Extruded EN AW-6060 aluminium structure (bollard version) with high corrosion resistance. Stone wash surface treatment prior to painting process. A4 grade Stainless Steel screws with 2,5-3% molybdenum content which increases the resistance against corrosion. Silicone gaskets. Painting Process : 3 Step Process

1) Surface treatment with BONDERITE. A heavy metal free chemical surface treatment containing ceramic nano particles giving a cohesive, inorganic and highly dense protective coating. 2) PRE POLYMERIZATION a process of introducing an epoxy primer with excellent characteristics to the paint which also offers very high resistance to oxidation due to its Zinc content. 3) POLYMERIZATION a process with the application of polyester powder with high resistance against UV rays and harsh weather conditions. Resistance test protection for Marine applications for 1200h. Mechanical resistance IK 06

LIGHTING PERFORMANCE

Toughened glass diffuser. LOR --. Colour rendering index CRI 80, Colour stability step 3.

INSTALLATION AND MAINTENANCE

The wiring of the fixtures must strictly respect the specifications. Where not provided by the fixture loop in /out or through wiring will cause infiltration of humidity and if in contact with the cables this may lead to an accelerated process of oxidation.

WIRING

MINI-COOL L 220mm and MINI-LOOK L 220mm hard wired with H07RN-F cable and fast connector IP68 included, COOL and LOOK L 290mm is supplied with single cable entry. Isolation: CLASS II . Available colours: White (cod.01), Black (cod.09), Aluminium grey (cod.14). Weight: 2.0583 Kg
Glow Wire test: --

LED module included

LOOK and COOL REGISTERED DESIGN

This luminaire contains built-in LED modules. In case of damage or malfunction please contact the manufacturer to receive additional instructions on how to replace and relative spare parts to order. The LED modules cannot be handled in the luminaire by the end user.

This product contains a light source of energy efficiency class (EPREL - European Product Registry for Energy Labelling): C.

LED modules are engineered accordingly to the existing regulations of Lumen Maintenance (LM80) and Technical Memorandum (TM21), where uniformity and quality of the light is 70,000 hours referred to L80 B10 Ta 25 ° C (50,000 hours referable to L80 B10 Ta 40°C). Lifespan of the luminaire min. 70.000 hours Ta 25°C, min. 50,000 hours at 40°C. Performance Ambient temperature Tq 25°C. Operating ambient temperature range is from -20°C to +50°C. Storage temperature range from -20°C to +60°C.

ELECTRONIC EQUIPMENT SENSITIVE TO OVERVOLTAGE.

We recommend installing surge protection devices "SPD" in the electrical system. Protection devices prevent the intensity of these phenomena's, protecting the appliances from the risk of being damaged and extending the lifespan. Outdoor luminaires are subject to all types of permanent, temporary, or transient electrical disturbances. Such disturbances can create permanent damage or failure affecting its performance and durability. The surge protection device (supplied by SIMES) is utilized to limit the destructive effect of these phenomena. We suggest that each luminaire must be connected to one protection device at not more than 10m away. For correct coordination of the protections, a surge protection device must also be provided inside the electrical panel of the system (the selection of this device must be carried out from the electrical designer and is not supplied by SIMES).

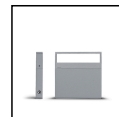
MINI-COOL BOLLARD H. 220mm**S.7236N.14 (Aluminium grey)****ACCESSORIES****S.2499****SURGE PROTECTION DEVICE 10kV CLASS II**

Compatible with all lighting fixtures and electronic ballast accessories classified under electrical Protection Class II Rated voltage 230-277V SPD type 2+3 Max Surge Protection 10kV IP67
EACH FIXTURE MUST BE CONNECTED TO ONE SINGLE SURGE PROTECTION DEVICE AT A DISTANCE OF NO MORE THAN 10m AWAY.

**S.5506****4 WAY GEL CONNECTOR**

For cables up to 3x2,5mm² diam. Min 6,5mm / Max 12mm IP68
Dimensions: 105 x 44 x 24 mm

**S.7249****FLANGE**

Steel flange with stainless steel screws (to be fixed in concrete).

**S.2495****DALI2 RELAY SWITCH for ON-OFF (NOT DIMMABLE) 230V LUMINAIRES**

Allows to make a remote control of ON-OFF not dimmable 230V luminaires via DALI2 protocol. IP20 Max nominal load 1000VA Max switching current 8A Max inrush current 80A Dimensions 32,5mm x 15mm x 58,5mm NB: the Luminaire can be controlled remotely in ON-OFF mode only and not in dimmed mode.

The total quantity of the Inrush currents of the luminaires/fixtures that you want to connect to the DALI2 RELAY SWITCH, must not exceed the maximum value of 80A.

**S.2496****DALI2 RELAY SWITCH for ON-OFF (NOT DIMMABLE) 230V LUMINAIRES**

Allows to make a remote control of ON-OFF not dimmable 230V luminaires via DALI2 protocol. IP67 Max nominal load 1000VA Max switching current 8A Max inrush current 80A Dimensions 175,5mm x 86,5mm x 43mm NB: the Luminaire can be controlled remotely in ON-OFF mode only and not in dimmed mode.

The total quantity of the Inrush currents of the luminaires/fixtures that you want to connect to the DALI2 RELAY SWITCH, must not exceed the maximum value of 80A.