

# Calvert





---

Inspired by Calvert Vaux, the mastermind behind New York's Central Park.  
Breaking up a grid system to create spaces to focus, collaborate,  
relax and inspire.

Steel frame walls, available in three heights, act as room dividers, with the louvre-style grid pattern diffusing visibility between areas without creating a definite wall.

Accessories, such as display cubes, shelves, AV boxes, dry-wipe surfaces and upholstered panels, along with benches and desk surfaces, can be incorporated to add flexible functionality.

Infinitely scalable, the system can grow, adapt and be reconfigured as spaces evolve and can be used to create landscapes from simple partitions to all-encompassing 'room-within-a-room' environments.

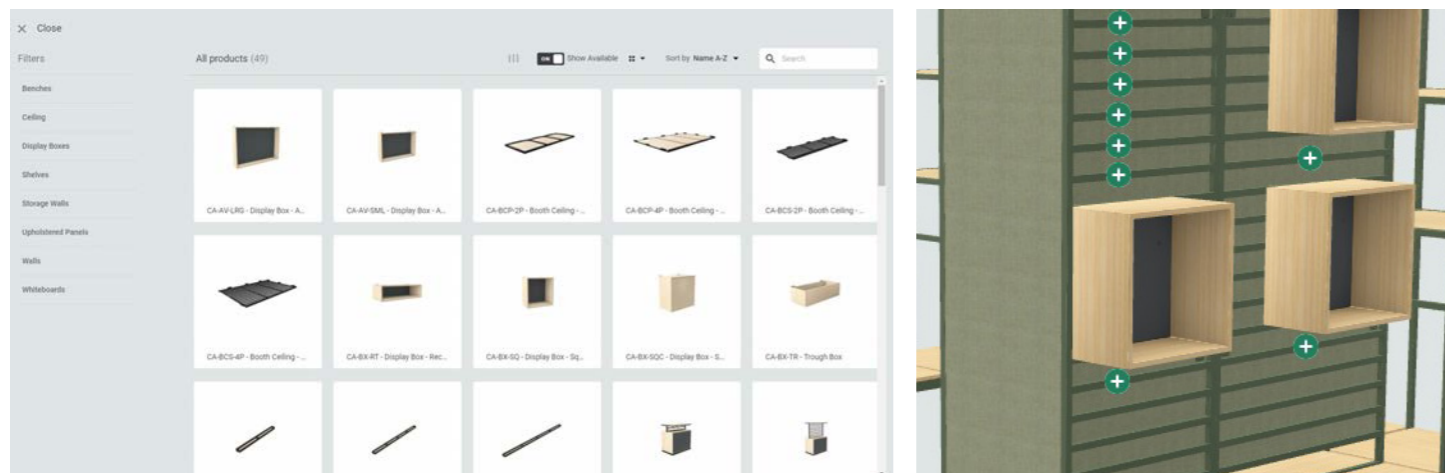
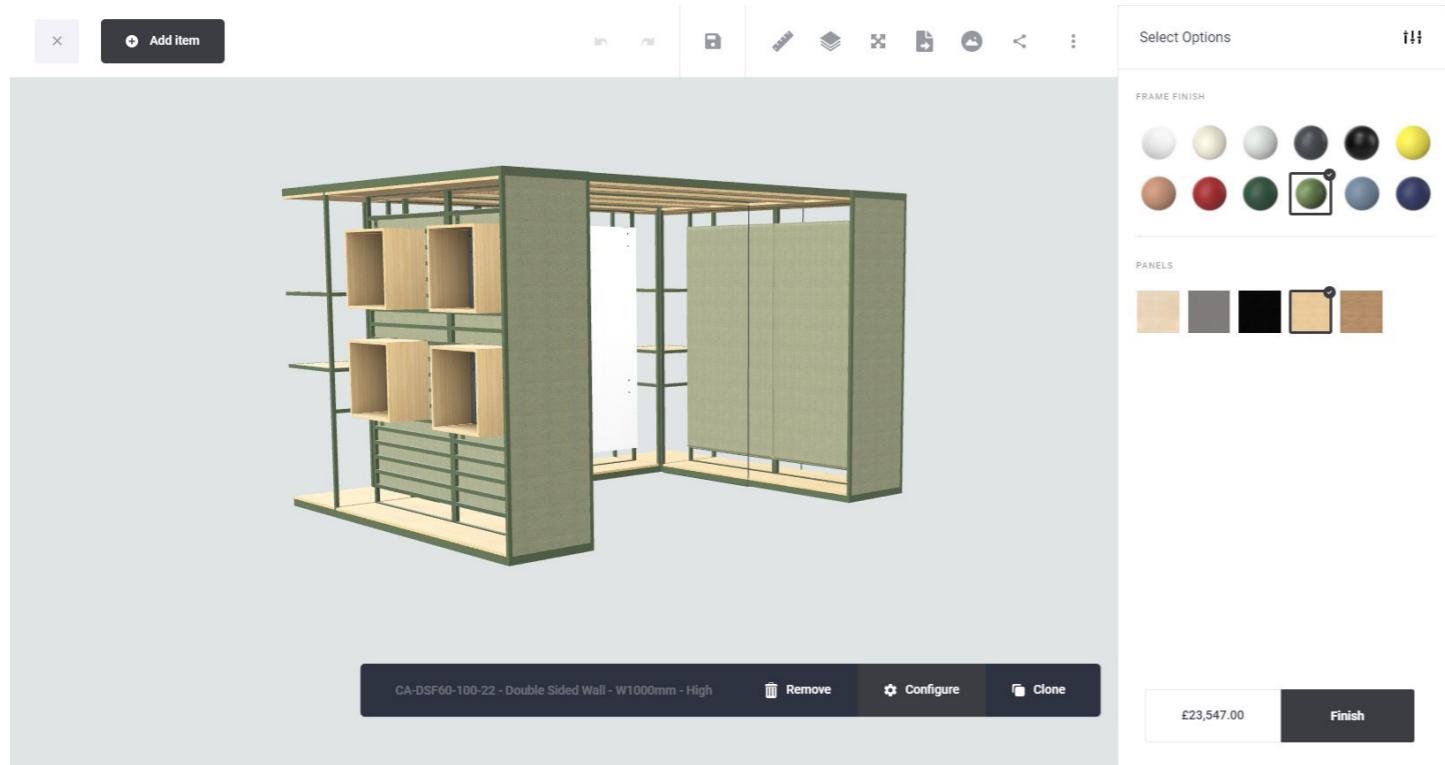

Our online product configurator allows customers to build and specify their perfect **Calvert** layout in 3D simply and easily.

Wall frames can be assembled in any number of ways within the parameters of the system, with Link Frames automatically inserted to alleviate any errors in construction.

Finishes and materials can be selected to customise the look of the product to tie in with your scheme.

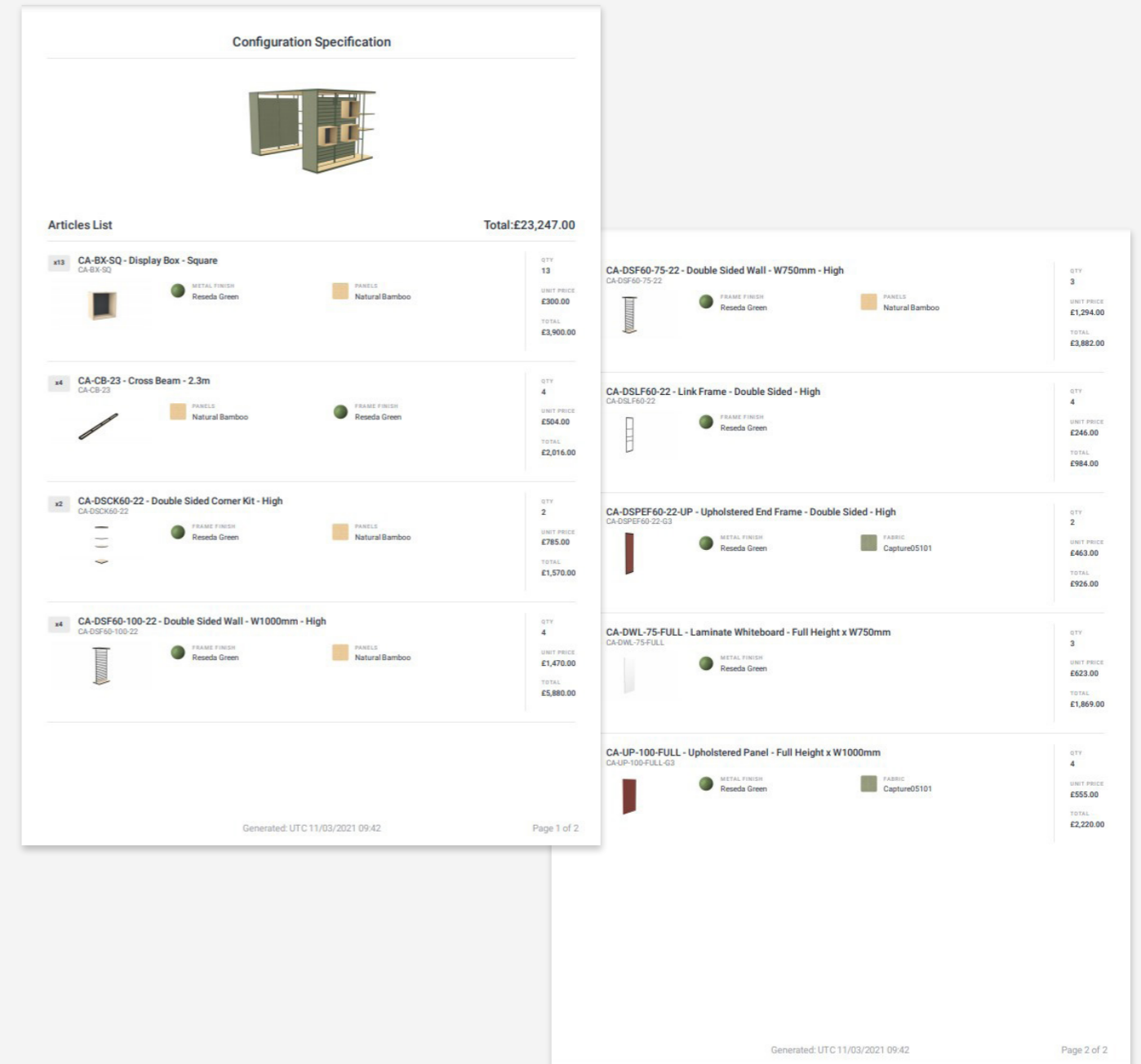

Once your perfect layouts are completed they can be shared with other users. High quality images from any view point can be generated for use in presentations, 3D files can be downloaded for integration into CAD models and a full component list, including finishes, created to aid in ordering.

Registered users can also access pricing, making specification, costing and ordering as simple as possible.

Contact a member of the Sales Team to arrange a quick training session and set up your account access.

EXAMPLE LAYOUTS



**Mid Height Storage Wall**

Product Codes

- 2x CA-DSCB100-15
- 2x CA-DSEF60-15
- 2x CA-SH-95
- 2x CA-BX-SQ

Dimensions

W2050 x D600  
x H1000mm



**Space Divider with Meeting Table**

- 3x CA-DSF60-100-22
- 2x CA-DSEF60-22
- 1x CA-ST-140
- 3x CA-BX-SQ
- 1x CA-AV-LRG
- 4x CA-SH-70
- 1x CA-DWG-50-50
- 1x CA-SNAKE-S

W3050 x D1715  
x H2200mm

EXAMPLE LAYOUTS



**Four Person Booth with Benches and Ceiling**  
Group 3 Fabrics

Product Codes

- 7x CA-SSF30-75-22
- 2x CA-SSEF30-22
- 4x CA-SSLF30-22
- 2x CA-SSCK30-22-2W
- 1x CA-BCP-4P
- 1x CA-SFPB-2-R
- 1x CA-SFPB-2-L
- 1x CA-ST-140
- 1x CA-AV-LRG
- 1x CA-SNAKE-S
- 4x CA-BX-SQ
- 7x CA-SH-70
- 2x CA-UP-50-50
- 12x CA-UP-70-20

Dimensions

W2950 x D1890  
x H2200mm



**Corner Divider Layout with Cupboards**

- 2x CA-DSF60-100-22
- 1x CA-DSF60-100-10
- 2x CA-CB100-22
- 1x CA-CB100-15
- 1x CA-CB100-10
- 4x CA-DSL60-22
- 1x CA-DSL60-15
- 2x CA-DSEF60-10
- 1x CA-DSCK60-22-2W
- 3x CA-SH-95
- 5x CA-BX-SQ
- 1x CA-BX-RT
- 1x CA-DWL-75-70

W3650 x D4650  
x H2200mm



**Space Divider with Drop-in Desks**

Product Codes

- 4x CA-DSF60-75-22
- 2x CA-DSSF60-22
- 4x CA-DID-150
- 2x CA-BX-SQ
- 2x CA-BX-RCT
- 4x CA-SH-70

Dimensions

W3050 x D1225  
x H2200mm

Additional loose furniture & accessories shown not included.



**Space Divider with Double Sided Benches**  
Group 3 Fabrics

- 3x CA-DSF60-100-22
- 2x CA-DSF60-75-22
- 2x CA-DSEF60-22
- 14x CA-BX-SQ
- 6x CA-RFPB-2

W4550 x D1460  
x H2200mm

Product Codes



**Divider with Drop-In Desks & Cupboard**  
Group 3 Fabrics

- 3x CA-DSF60-75-22
- 2x CA-DSL60-22
- 1x CA-DSF60-75-10
- 1x CA-DSEF60-10
- 1x CA-CB100-15
- 1x CA-DSEF60-15
- 6x CA-DID-75
- 6x CA-UP-70-20

Dimensions

W3350 x D1225  
x H2200mm

Additional loose furniture & accessories shown not included.



**Single-Sided Wall Fixed Setup with Benches**  
Group 3 Fabrics

- 1x CA-SSEF30-22
- 1x CA-SSF30-100-22
- 3x CA-SSLF30-22
- 1x CA-SSF30-100-10
- 1x CA-SSLF30-15
- 2x CA-SSF30-75-15
- 3x CA-SSF30-75-22
- 1x CA-SSF30-75-10
- 1x CA-SSEF30-10
- 1x CA-SFPB-2-L
- 1x CA-SFPB-2-R
- 1x CA-ST-140
- 7x CA-SH-70
- 3x CA-BX-SQ
- 4x CA-DWG-50-50
- 3x CA-UP-50-50

W6650 x D1600  
x H2200mm



**WALL HEIGHTS:**

All walls & storage walls available in three heights



**Low**  
H1000mm  
Replace 'xx' with '10'



**Mid**  
H1500mm  
Replace 'xx' with '15'



**High**  
H2200mm  
Replace 'xx' with '22'

**SINGLE SIDED WALLS:**

Illustrations show mid height option



**750mm Wide**  
CA-SSF30-75-xx  
W750 x D338mm



**1000mm Wide**  
CA-SSF30-100-xx  
W1000 x D338mm



**750mm Wide Storage Wall**  
CA-SSCB30-75-xx  
W750 x D600mm



**1000mm Wide Storage Wall**  
CA-SSCB30-100-xx  
W1000 x D600mm

Single Sided Wall frames must be wall or floor fixed, unless used in self-supporting layouts.

**DOUBLE SIDED WALLS:**

Illustrations show mid height option



**750mm Wide**  
CA-DSF30-75-xx  
W750 x D600mm



**1000mm Wide**  
CA-DSF30-100-xx  
W1000 x D600mm



**750mm Wide Storage Wall**  
CA-DSCB30-75-xx  
W750 x D600mm



**1000mm Wide Storage Wall**  
CA-DSCB30-100-xx  
W1000 x D600mm

For additional stability Wall Frames can be floor fixed. Alternatively, Steel weighted ballasts can be fitted to base panels

Tops of High Walls used in open atrium areas can be supplied with additional top panels to cap off visibility of fixings or cabling.

**PLANTERS**

Add planters to top of Low or Mid Frames. Solid finish options as per Wall Frames.

	750mm Wide Single Sided	750mm Wide Double Sided	1000mm Wide Single Sided	1000mm Wide Double Sided
<b>Product Code</b>	+PL	+PL	+PL	+PL

**Note:** Plants not included. For real planting waterproof lining will be required.



**CASTORS**

Optional castors make wall frames mobile, for added flexibility in open-plan spaces. (Maximum 3 Walls linked)

Double Sided Low & Mid Walls only require plain castors. Single Sided Walls and High Double Sided Walls include outrigger feet.

**Adding Castors increases height by 50mm**



Outrigger Feet



**END FRAMES:**

End Frames need to be fitted to the ends of all wall runs, capping off fixing holes, aiding rigidity and creating an enclosed frame appearance.

When additional rigidity is required, such as when Drop-in Desks are used, Slatted or Panelled End Frames are recommended.

Panelled End Frames available in Birch Ply, Valchromat in Light Grey or Brack, or Upholstered.

**END FRAMES**



**Single Sided**

**Product Code**

Low: CA-SSEF30-10  
Mid: CA-SSEF30-15  
High: CA-SSEF30-22

**Dimensions**

W25 x D338 x  
H1000/1500/2200mm

**Double Sided**

Low: CA-DSEF60-10  
Mid: CA-DSEF60-15  
High: CA-DSEF60-22

W25 x D600 x  
H1000/1500/2200mm

**SLATTED END FRAMES**



**Single Sided**

**Product Code**

Low: CA-SSSF30-10  
Mid: CA-SSSF30-15  
High: CA-SSSF30-22

**Dimensions**

W25 x D338 x  
H1000/1500/2200mm

**Double Sided**

Low: CA-DSSF60-10  
Mid: CA-DSSF60-15  
High: CA-DSSF60-22

W25 x D600 x  
H1000/1500/2200mm

**PANELLED END FRAMES**



**Single Sided**

**Product Code**

Low: CA-SSPEF30-10  
Mid: CA-SSPEF30-15  
High: CA-SSPEF30-22

**Dimensions**

W25 x D338 x  
H1000/1500/2200mm

**Double Sided**

Low: CA-DSPEF60-10  
Mid: CA-DSPEF60-15  
High: CA-DSPEF60-22

W25 x D600 x  
H1000/1500/2200mm



LINK FRAMES & CORNER KITS:

Link Frames allow walls of varying heights to be connected, as well as providing fixing points for Corner Kits.

Corner Kits allow for two, three or four walls to be joined at triangular or square intersections. Create a simple change of direction, or link several wall runs together to create multiple enclosed areas.

Powder coated metalwork available in standard colours, as per frames.  
Panel elements available in Natural Birch Ply, Valchromat in Light Grey or Black.

LINK FRAMES



	Single-Sided	Double-Sided
<b>Product Code</b>	Low: CA-SSLF30-10 Mid: CA-SSLF30-15 High: CA-SSLF30-22	Low: CA-DSLF60-10 Mid: CA-DSLF60-15 High: CA-DSLF60-22
<b>Dimensions</b>	W25 x D338 x H1000/1500/2200mm	W25 x D600 x H1000/1500/2200mm

CORNER KITS



	Low	Mid	High
<b>Single Sided</b>	2-Way: CA-SSCK30-10-2W 3-Way: CA-SSCK30-10-3W 4-Way: CA-SSCK30-10-4W	2-Way: CA-SSCK30-15-2W 3-Way: CA-SSCK30-15-3W 4-Way: CA-SSCK30-15-4W	2-Way: CA-SSCK30-22-2W 3-Way: CA-SSCK30-22-3W 4-Way: CA-SSCK30-22-4W
<b>Dimensions</b>	W338 x D338 x H1000mm	W338 x D338 x H1500mm	W338 x D338 x H2200mm
<b>Double Sided</b>	2-Way: CA-DSCCK60-10-2W 3-Way: CA-DSCCK60-10-3W 4-Way: CA-DSCCK60-10-4W	2-Way: CA-DSCCK60-15-2W 3-Way: CA-DSCCK60-15-3W 4-Way: CA-DSCCK60-15-4W	2-Way: CA-DSCCK60-22-2W 3-Way: CA-DSCCK60-22-3W 4-Way: CA-DSCCK60-22-4W
<b>Dimensions</b>	W600 x D600 x H1000mm	W600 x D600 x H1500mm	W600 x D600 x H2200mm
<b>Double to Single Sided</b>	2-Way: CA-DSSCK-10-2W 3-Way: CA-DSSCK-10-3W 4-Way: CA-DSSCK-10-4W	2-Way: CA-DSSCK-15-2W 3-Way: CA-DSSCK-15-3W 4-Way: CA-DSSCK-15-4W	2-Way: CA-DSSCK-22-2W 3-Way: CA-DSSCK-22-3W 4-Way: CA-DSSCK-22-4W
<b>Dimensions</b>	W338 x D600 x H1000mm	W338 x D600 x H1500mm	W338 x D600 x H2200mm
<b>Double to Single Sided</b>	2-Way: CA-TRCK-10-2W 3-Way: CA-TRCK-10-3W	2-Way: CA-TRCK-15-2W 3-Way: CA-TRCK-15-3W	2-Way: CA-TRCK-22-2W 3-Way: CA-TRCK-22-3W
<b>Dimensions</b>	W600 x D520 x H1000mm	W600 x D520 x H1500mm	W600 x D520 x H2200mm

# Calvert



# Calvert

## TABLES



	Small Standard Height	Small Poseur Height	Large Standard Height	Large Poseur Height
Product Code	CA-ST-100	CA-PT-100	CA-ST-140	CA-PT-140
Dimensions	W750 x D1000 x H725mm	W750 x D1000 x H1025mm	W750 x D1400 x H725mm	W750 x D1400 x H1025mm

## DROP-IN DESKS



	W750mm	W1000mm	W1500mm	W2000mm
Product Code	CA-DID-75	CA-DID-100	CA-DID-150	CA-DID-200
Dimensions	W750 x D600mm	W1000 x D600mm	W1500 x D600mm	W2000 x D600mm

Drop-in Desks are hooked onto wall frames allowing for flexibility in working height.

When Drop-in Desks are specified either Slatted or Panelled End Frames should be used to reduce any movement in the frame.

Drop-in Desks include an upholstered modesty panel in **Camira Blazer** in the following colours as standard. Please specify when ordering. Custom fabrics available on request. P.O.A.



## DISPLAY BOXES



	Square Box	Rectangular Box
Product Code	CA-BX-SQ	CA-BX-RT
Dimensions	W500 x H500 x D285mm	W700 x H200 x D285mm



	Trough Box	Square Cupboard With Push to Open catch	Small AV Box Fits up to 28" screen	Large AV Box Fits up to 40" screen
Product Code	CA-BX-TR	CA-BX-SQC	CA-AV-SML	CA-AV-LRG
Dimensions	W700 x H200 x D285mm	W500 x H500 x D285mm	W750 x H500 x D150mm	W1000 x H700 x D150mm

## SHELVES



	W700mm Shelf	W950mm Shelf
Product Code	CA-SH-70	CA-SH-95
Dimensions	W700 x D265mm	W950 x D265mm





Saddle Brackets can be fastened to customer's own accessories to allow fixing to wall frames.

ACCESSORIES

	<b>S-Hook</b>	<b>Optic</b>	<b>Magnets</b> Set of 4no.	<b>Saddle Bracket</b>
<b>Product Code</b>	CA-HOOK	CA-OPT	CA-MAGS	CA-SADL
<b>Dimensions</b>	W25 x D67 x H125mm	W80 x W80 x H380mm	W10 x D10 x H10mm	W40 x D35 x H205mm

Powder coated S-Hook, Optic bracket or Saddle Bracket available in 12 Standard or 3 Premium colours. For Premium colour no upcharge needed, although minimum order may apply if ordering in isolation.

CABLE SNAKES

	<b>Short Fabric Cable Snake</b>	<b>Long Fabric Cable Snake</b>
<b>Product Code</b>	CA-SNAKE-S	CA-SNAKE-L
<b>Dimensions</b>	Length: 625mm	Length: 925mm

Cable Snake Finishes:

Camira Blazer in the following colours as standard. Zip fastening with magnetic attachment to 'Calvert' frame.



Please specify when ordering. Custom fabrics & lengths available on request. P.O.A.



LAMINATE WHITEBOARDS

	<b>Square Laminate</b>	<b>H700mm x W750mm Laminate</b>	<b>H700mm x W1000mm Laminate</b>	<b>Full Height x W750mm Laminate</b>	<b>Full Height x W1000mm Laminate</b>
<b>Product Code</b>	CA-DWL-50-50	CA-DWL-75-70	CA-DWL-100-70	CA-DWL-75-FULL	CA-DWL-100-FULL
<b>Dimensions</b>	W500 x H500mm	W750 x H700mm	W1000 x H700mm	W750 x H1825mm	W1000 x H1825mm





GLASS MAGNETIC WHITEBOARDS

	<b>Square Glass</b>	<b>H650mm x W1000mm Glass</b>	<b>Full Height x W1000mm Glass</b>
<b>Product Code</b>	CA-DWG-50-50	CA-DWG-100-65	CA-DWG-100-FULL
<b>Dimensions</b>	W500 x H500mm	W1000 x H650mm	W1000 x H1825mm





# Calvert



## UPHOLSTERED PANELS



				
	<b>Square</b>	<b>Rectangular</b>	<b>H500 x W750mm</b>	<b>H500 x W1000mm</b>
<b>Product Code</b>	CA-UP-50-50	CA-UP-70-20	CA-UP-75-50	CA-UP-100-50
<b>Dimensions</b>	W500 x H500mm	W700 x H200mm	W750 x H500mm	W1000 x H500mm

Fabric Upholstery over plywood with acoustic foam padding.  
Large panels may include central seam to reduce fabric waste.

				
	<b>H700 x W750mm</b>	<b>H700 x W1000mm</b>	<b>Full Height x W750mm</b>	<b>Full Height x W1000mm</b>
<b>Product Code</b>	CA-UP-75-70	CA-UP-100-70	CA-UP-75-FULL	CA-UP-100-FULL
<b>Dimensions</b>	W750 x H700mm	W1000 x H700mm	W750 x H1825mm	W1000 x H1825mm

## FABRIC WEAVES







		
	<b>Cupboard Height Set of 4</b>	<b>Full Height Set of 4</b>
<b>Product Code</b>	CA-CH-WV	CA-FH-WV
	Fabric weaves only available in multiples of 4no. Magnetic fixings included.	

# Calvert







## SIDE FIX SEATING

				
	<b>Single Bench</b>	<b>Double Bench</b>	<b>Single Park Bench</b>	<b>Double Park Bench</b>
<b>Product Code</b>	Right: CA-SFB-1-R Left: CA-SFB-1-L	Right: CA-SFB-2-R Left: CA-SFB-2-L	Right: CA-SFPB-1-R Left: CA-SFPB-1-L	Right: CA-SFPB-2-R Left: CA-SFPB-2-L
<b>Dimensions</b>	W750 x H800 x D750 x SH475mm	W1500 x H800 x D750 x SH475mm	W750 x H800 x D750 x SH475mm	W1500 x H800 x D750 x SH475mm



Please Note: Illustrations show Right arm units.

## REAR FIX SEATING



				
	<b>Single Bench</b>	<b>Double Bench</b>	<b>Single Park Bench</b>	<b>Double Park Bench</b>
<b>Product Code</b>	CA-RFB-1	CA-RFB-2	CA-RFPB-1	CA-RFPB-2
<b>Dimensions</b>	W750 x H800 x D750 x SH475mm	W1500 x H800 x D750 x SH475mm	W750 x H800 x D750 x SH475mm	W1500 x H800 x D750 x SH475mm



CROSS BEAMS

			
	<b>1.55m Cross Beam</b>	<b>2.3m Cross Beam</b>	<b>3m Cross Beam</b>
<b>Product Code</b>	CA-CB-15	CA-CB-23	CA-CB-30
<b>Dimensions</b>	W1550 X D150mm	W2300 X D150mm	W3000 X D150mm

CEILING FRAMES

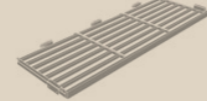
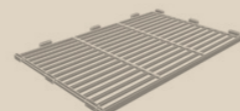
				
	<b>Two-Person Panelled Booth Ceiling</b>	<b>Four-Person Panelled Booth Ceiling</b>	<b>Two-Person Slatted Booth Ceiling</b>	<b>Four-Person Slatted Booth Ceiling</b>
<b>Product Code</b>	CA-BCP-2P	CA-BCP-4P	CA-BCS-2P	CA-BCS-4P
<b>Dimensions</b>	W2300 X D800mm	W2300 X D1550mm	W2300 X D800mm	W2300 X D1550mm

Use Ceiling Frames with High Wall Units to create intimate booth-type shelters within open plan spaces.

Customer's own lighting can be fitted to ceiling boards or beams.

Finishes:

METAL FINISHES:





						
	Signal White RAL 9003	Oyster White RAL 1013	Light Grey RAL 7035	Graphite Grey RAL 7024	Jet Black RAL 9005	Zinc Yellow RAL 1018
<b>RAL:</b>						
	Beige Red RAL 3012	Ruby Red RAL 3003	Moss Green RAL 6005	Reseda Green RAL 6011	Sapphire Blue RAL 5003	Pigeon Blue RAL 5014
<b>PREMIUM:</b>						
	Quartz	Golden Brown	Rust Mica			

SOLID MATERIALS:

				
Birch Plywood*	Grey Valchromat	Black Valchromat	Natural Bamboo	Caramel Bamboo

Custom finishes available on request. P.O.A.

MFC - CUPBOARDS & TABLETOPS:

			
Birch MFC	White MFC	Grey MFC	Black MFC

PERFECTSENSE - CUPBOARDS & TABLETOPS:

		
White	Graphite Grey	Black

CUPBOARDS & DISPLAY BOXES:

				
Birch Plywood* & Grey Laminate	Grey Valchromat & Grey Laminate	Black Valchromat & Grey Laminate	Natural Bamboo & Grey Laminate	Caramel Bamboo & Grey Laminate

Custom finishes available on request. P.O.A.

**\*Birch Plywood Note:** We use a high quality B/BB grade plywood board with a water-based clear lacquer. While care is taken to avoid any large knots or visible plugs these may still appear and are in keeping with the natural appearance of the material.

# Calvert

## PRODUCT MATERIAL BREAKDOWN

Material Breakdown Data based on example **Calvert** setup with Bamboo panels using the following parts:  
3x CA-DSF60-75-22  
2x CA-DSEF60-22  
8x CA-SH-70  
4x CA-BX-SQ

Figures stated will vary depending on components & finishes used.

Recycled data based on supplier information and industry averages. As part of our continuous development processes we will review this information regularly and data may change without notice.

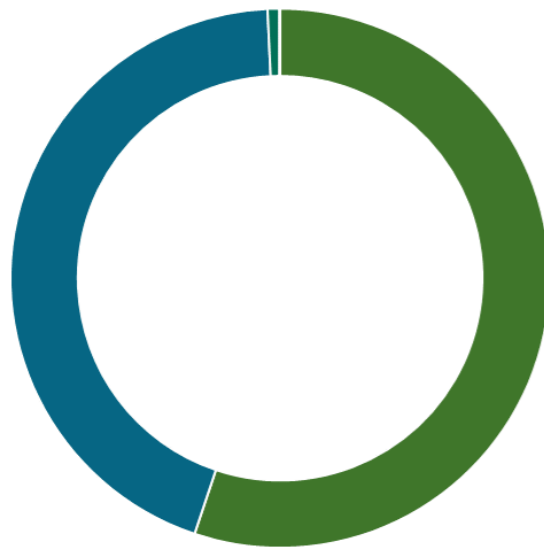

55%	MILD STEEL
44%	BAMBOO
0.7%	POLYESTER POWDER COAT
0.09%	PLATED MILD STEEL FIXINGS
<0.01%	PU

## SUSTAINABILITY

28%	RECYCLED CONTENT
99%	RECYCLABLE

This product has been designed using high quality materials and craftsmanship to ensure its longevity, however at the end of this products life it can be returned to **sixteen3** for refurbishment or recycling.

## Warranty Information

### 5 YEAR - NORMAL FAIR WEAR & TEAR

This includes the structure and any foam/padding materials. Fabrics are covered by fabric manufacturers' warranties, usually 5 years, dependant on fabric choice.

Please refer to full **sixteen3** Warranty information document for more details. **sixteen3** Ltd reserve the right to update product data information without prior notice.

## Cleaning & Maintenance

### GENERAL MAINTENANCE

- Vacuum upholstery regularly to remove dust and grit.
- Most hard surfaces can be cleaned with a soft cloth, dampened with a small amount of water and buffed dry.
- Clean spills and stains quickly to prevent them setting in (see specific fabric care instructions below).
- If being used in a spill/stain prone area specify an appropriate finish with stain-repellent properties.

**Refer to fabric manufacturers own guidelines for specific information.**

### NATURAL FABRICS

In addition to regular vacuuming, wool and other natura fibres can usually be cleaned using appropriate upholstery shampoo. For a deeper clean it is best that wool be dry cleaned, as over-wetting can cause shrinkage and appearance change. Never apply bleach, ammonia, alkali or strong acids to wool upholstery.

### SYNTHETIC FABRICS

Vacuuming is the best regular maintenance followed by speed of action to remove spills and stains rapidly as soon as they occur. Most synthetic fabrics can be wiped down with a water soaked damp cloth without fear of damaging fibre or removing colour. Stubborn stains can be removed with a quality upholstery shampoo.

### LEATHER

Leather should be regularly dusted with a soft cloth and vacuumed with a soft brush extension. Most types of aniline can also be treated with specialist products to help preserve colour/finish etc. As leather is a natural material, discrepancies in surface texture and 'puddling' in seat areas is to be expected.

### WOOD FINISHES

Clean surfaces regularly with a slightly damp cloth and buff dry with a soft duster. The finish on all wood and laminate surfaces is designed to withstand moderate heat and some spillages, but all spillages should be wiped off with a damp cloth straight away. Do not drag any objects across any table tops. Certain wood finishes will naturally change in appearance with age. We cannot guarantee an exact match of any timber products.

### POWDER COATED & PAINTED

Clean surfaces regularly with a slightly damp cloth and a mild solution of soapy water. Buff dry with a soft duster.

### POLISHED METAL

Clean surfaces regularly with a soft cloth. A high quality chrome cleaner can be used to protect against tarnish and maintain the reflective finish.

### PLASTICS

Clean surfaces regularly with a slightly damp cloth and a mild solution of soapy water. Buff dry with a soft duster.



**CONTACT**

+44 1925 850 500  
info@sixteen3.co.uk  
@sixteen3\_ltd

**HQ:**  
Unit 2, Westway21  
Chesford Grange  
Woolston, Warrington  
Cheshire  
WA1 4SZ

**London:**  
25 Bastwick St  
Clerkenwell  
London  
EC1V 3PS

**Manchester:**  
Material Source Studio  
1 Federation St  
NOMA  
Manchester  
M4 4BF