

# SCREEN

Francesco Rota | 2016

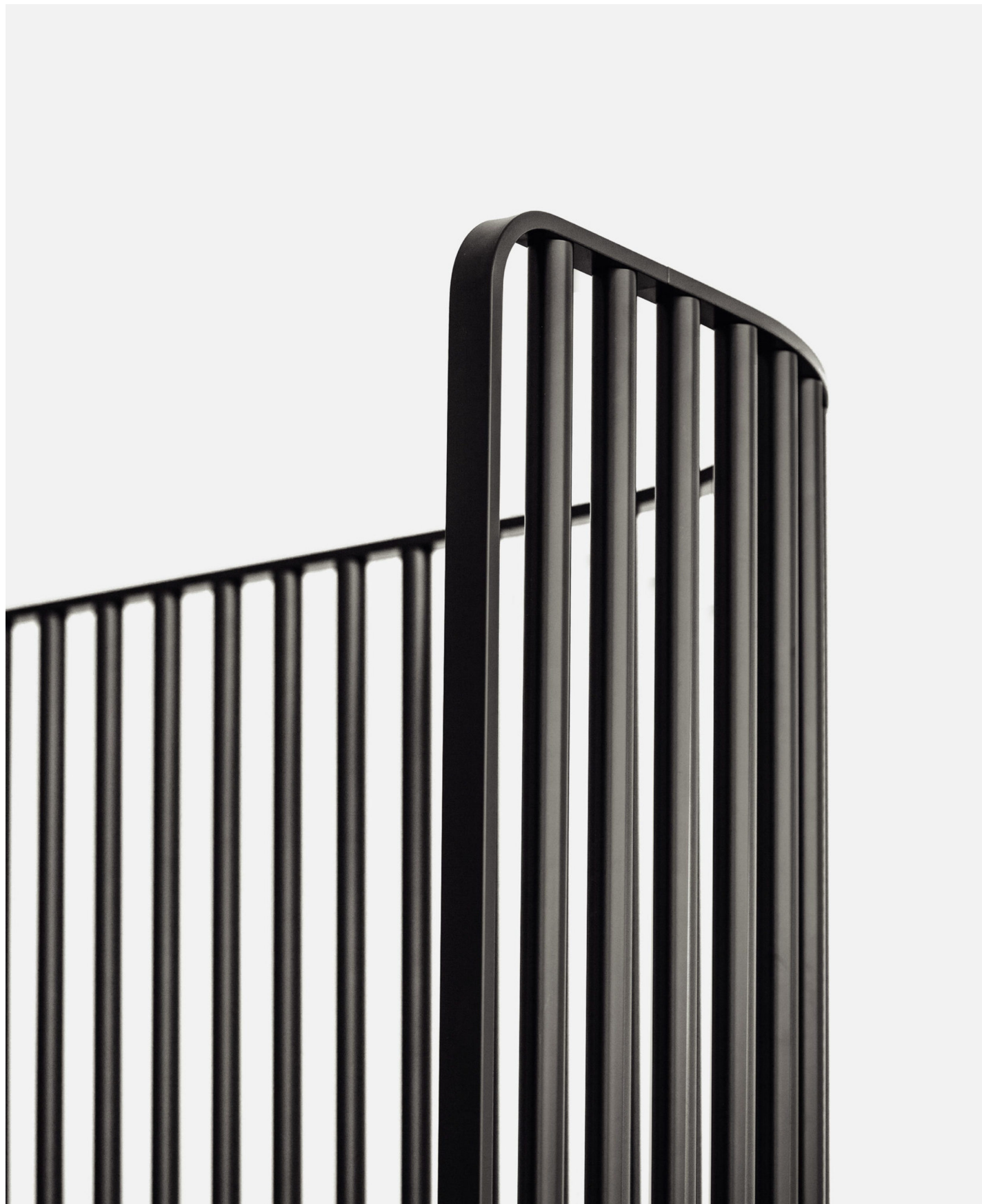

# SCREEN

Francesco Rota | 2016

Like punctuation, SCREEN panels coordinate the lines of the contemporary office. In the wide open space, the partition system created by Francesco Rota allows each work station to be defined, thanks to magnet linking system. It is an elegant “invisible” element that provides privacy in a light version. Maximum versatility for heights and for tubular wood solutions or a sound-absorbing fabric panel. The space stays open, the mind can concentrate and rest.





S – short



S – medium

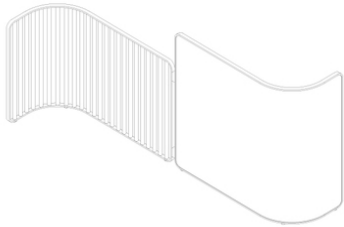

S – long

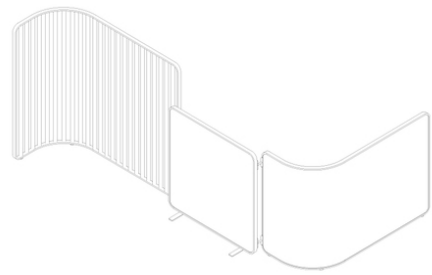

S – mixed

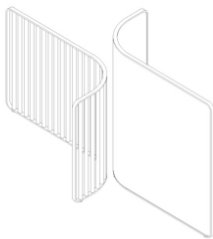

X\_shape

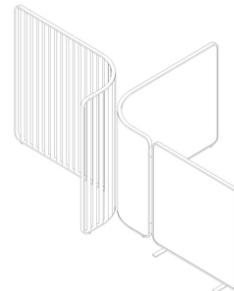

X\_shape – big



C – short

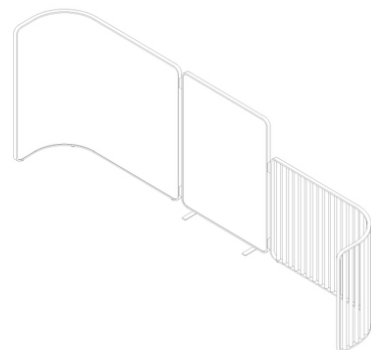

C – long

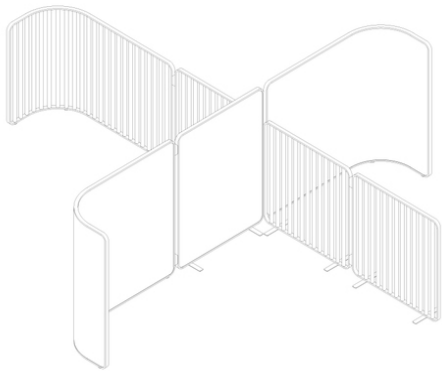

Intersections - 4

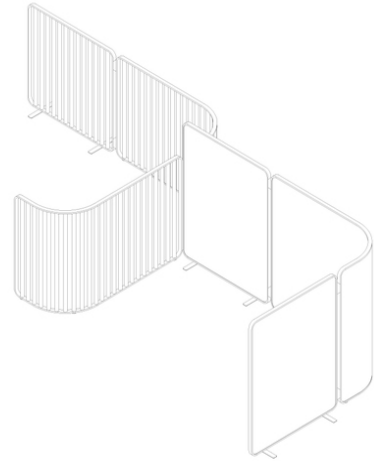

Intersections - 3

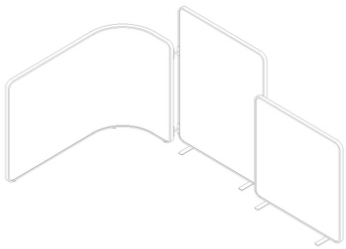

L\_shape

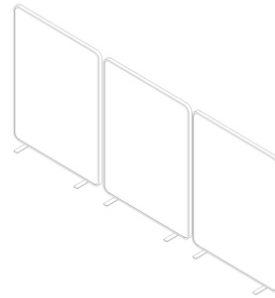

Wall shape

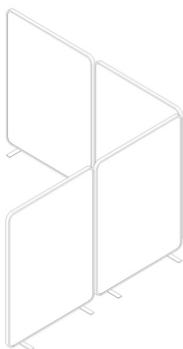

Corner shape

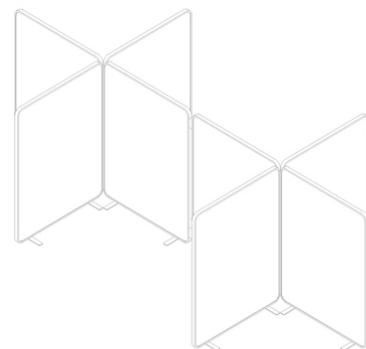

Cross shape

# SCREEN

Francesco Rota | 2016



Partition with steel frame and tubes in aluminium either powder coated or veneered in blanched oak, oak black stained or upholstered with fabric. Metal feet are included for the straight partition and optional for the curved version

TEST Sound absorption - class C - Maya  
TEST Fire resistance - class 1 - Medley

## magnets

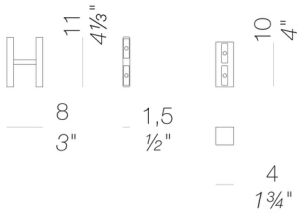

## partition system

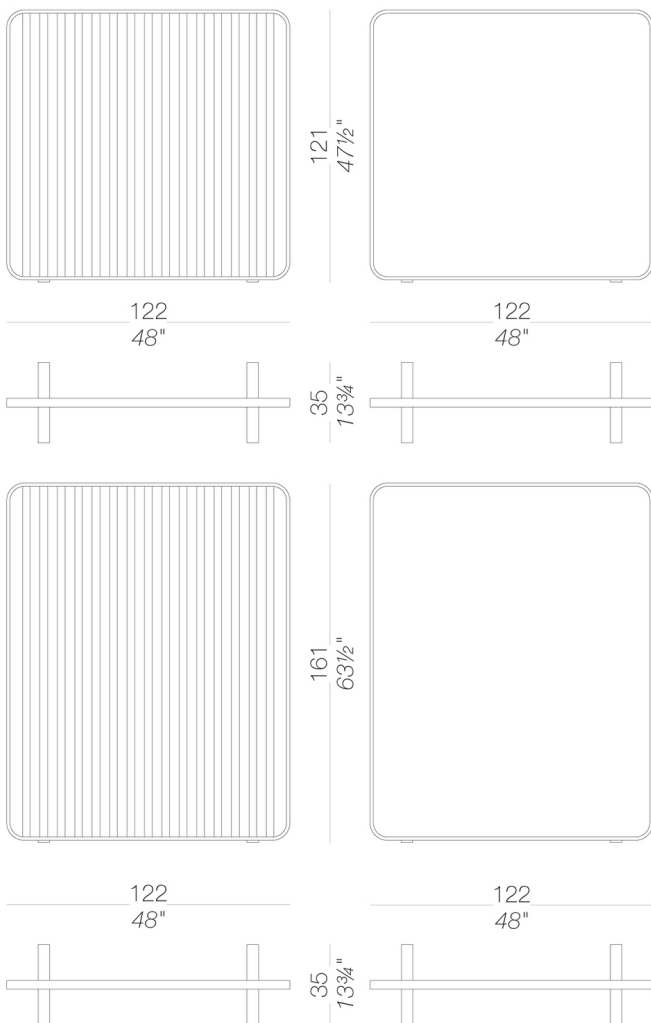

# SCREEN

Francesco Rota | 2016



# SCREEN

Francesco Rota | 2016

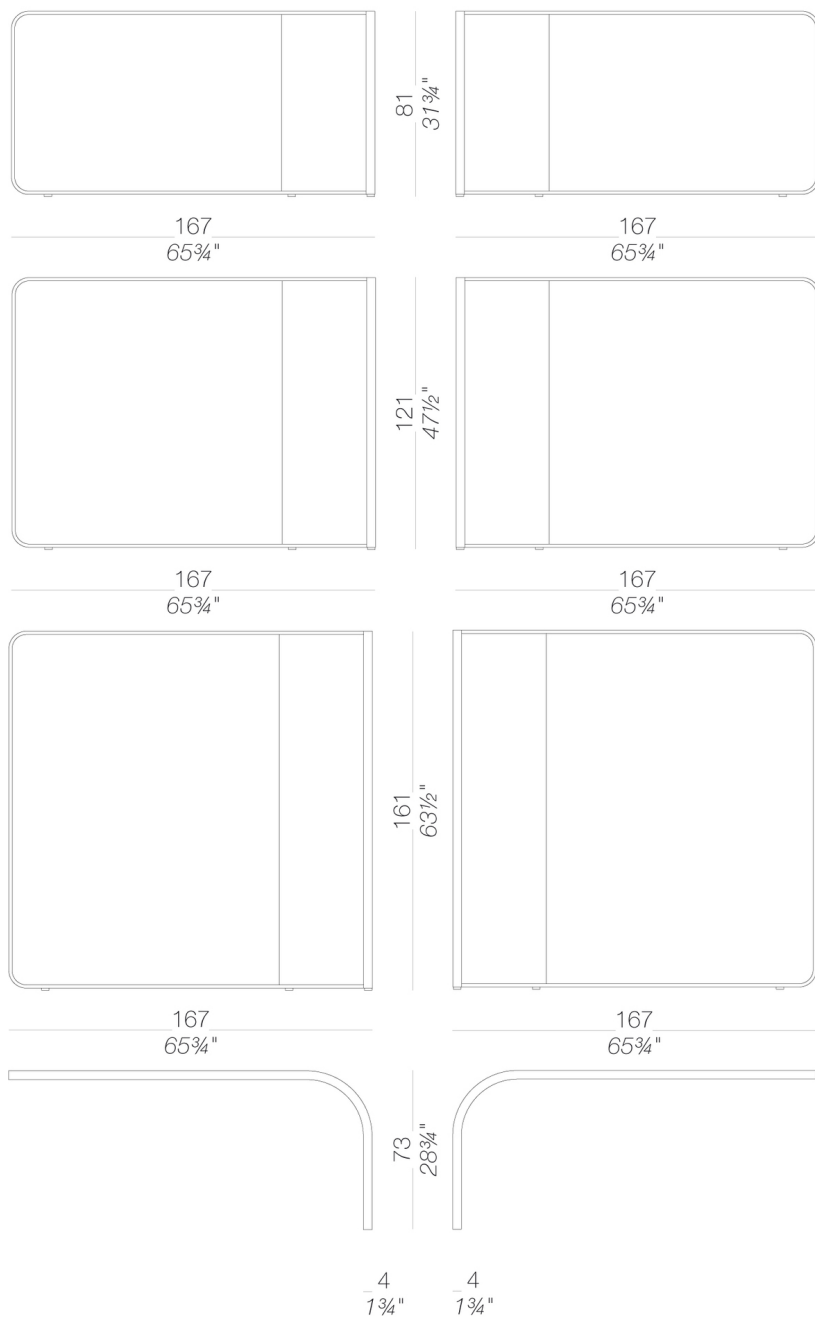

# SCREEN

Francesco Rota | 2016

## frame



powder coating  
black  
1 Colors



powder coating  
white  
1 Colors

## tubes



wood  
blanch oak  
1 Colors



fabric  
Uniform Melange -  
Grade E  
38 Colors

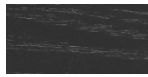

wood  
black open pore  
1 Colors



powder coating  
black  
1 Colors



powder coating  
white  
1 Colors

## upholstery

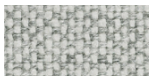

fabric  
Hallingdal 65 -  
Grade C  
58 Colors



fabric  
Canvas 2 - Grade C  
45 Colors



fabric  
Steelcut Trio 3 -  
Grade D  
54 Colors

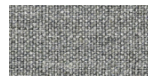

fabric  
Remix 3 - Grade C  
72 Colors



fabric  
Clara 2 - Grade C  
24 Colors



fabric  
Divina MD - Grade D  
27 Colors



fabric  
Divina Melange 3 -  
Grade D  
38 Colors



fabric  
Medley - Grade A  
37 Colors

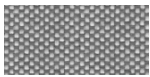

fabric  
Maya - Grade A  
43 Colors



fabric  
Jet - Grade A  
66 Colors



fabric  
Fiord 2 - Grade C  
39 Colors



fabric  
Tonica 2 - Grade C  
39 Colors

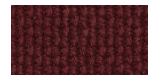

fabric  
Lapalma Smart -  
Grade C  
18 Colors

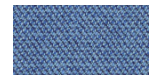

fabric  
Capture - Grade B  
43 Colors



fabric  
Crisp - Grade B  
40 Colors



fabric  
Nattè - Grade B  
30 Colors



fabric  
Iris - Grade B  
24 Colors



fabric  
Steelcut 3 - Grade D  
40 Colors

**consult the portfolio for the range of colors, fabrics, eco-leather, soft-leather.**

### use and maintenance instructions

Clean all parts in wood, leather, fabric and metal with a damp cloth or a diluted neutral cleaner. Do not use cleaners with alcohol, bleach, solvent or abrasive products. Any liquid spilt on the product must be wiped up immediately. When lifting or moving the product, hold it on the structure and not under the seat. The product should not be subjected to unbalanced weights, as it is designed for a proper rest on the foothold (on four legs or on the base). Our company relieves from any responsibility in case of damage caused to fragile floors. Avoid any improper use of the product: do not step on the product, on the footrest or on the armrests. Avoid any movements that could compromise the proper functionality of the product or the safety of the users. Wood and leather, being natural materials, could be easily damaged. Small impurities or imperfections are within quality standard range. Do not expose the product to weather conditions or atmospheric agents, nor to heat sources over 40°C. Also products for outdoor use could be afflicted by atmospheric agents. The product could undergo possible exterior changes due to particular exposure to heat, humidity and saltiness. An appropriate and frequent maintenance and cleaning of the product enhances its durability. The product could change colour and shade, if exposed to direct sunlight. Maintenance has to be carried out by experienced staff. Dispose of the package only after assembling the product, in order to avoid the loss of ironmongery and components. Once the product has been dismantled, the product itself or its components must be given to the public garbage disposal system, according to the legislation in force.