

Framery 2Q

The soundproof meeting room
for teams of up to 6

07/2023



Framery 2Q is designed for 4–6 people. This meeting pod is the ideal place to co-create, brainstorm and meet together. Framery's superior sound insulation and echo-free acoustics ensure that your meetings won't disturb the office – and the office noise won't disturb you.

Framery 2Q – The soundproof meeting room for teams of up to 6



Framery 2Q Huddle

Framery 2Q Huddle is the ideal setup for meetings - whether attendees are present, joining remotely, or anything in between. Gather your team around the table where everyone fits comfortably - even with their laptops. The spacious pod allows everyone to move around freely, and bring additional seating if needed.



Framery 2Q Lounge

Framery 2Q Lounge interior layout provides a more casual environment. It's perfect for relaxed company meetings, a calm space to retreat to during the workday, or an area for socialization. Custom-designed Clint Sofa, large whiteboard, free-standing Piaggio table and a wall shelf create a functional yet relaxed setting.



Framery 2Q without furniture

Choose the Framery 2Q meeting pod without furniture to furnish it the way you like. The superb sound insulation ensures you and your team total sound privacy and the adjustable airflow keeps the atmosphere fresh. A low doorstep makes the Framery 2Q wheelchair accessible.

Framery 2Q / Furniture

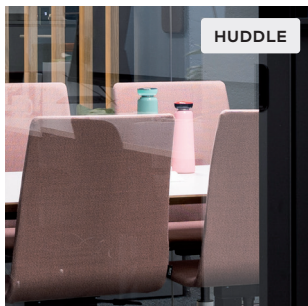

HUDDLE

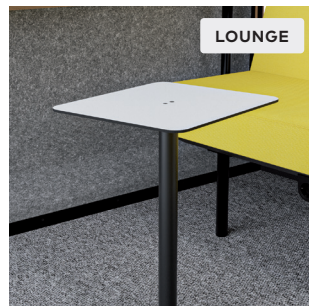

LOUNGE

FRAMERY 2Q HUDDLE comes with standard (72 cm / 28.3 in) or high table (110 cm / 43.3 in). Gather your team of four around a spacious table where everyone fits comfortably, laptops included. There is enough space for overflow seating if more team mates drop by.

FRAMERY 2Q LOUNGE comes with custom-designed Clint Sofa, large whiteboard, free-standing Piaggio table and a wall shelf which were designed to create a functional yet relaxed setting for meetings and brainstorming sessions.

Framery 2Q / Colors

EXTERIOR



White (Standard)
RAL 9016 Glossy



White
RAL 9016 Ultramatt



Black
RAL 9005 Ultramatt



Gray
S7500-N Ultramatt



Navy
S 7020 - R90B Ultramatt



Sand
S 2010 - Y20R Ultramatt



Powder Blue
3421-R86B Ultramatt



Winter Moss
S 7010-G10Y Ultramatt



Blush
2728-R01B Ultramatt

INTERIOR



Light Gray Felt (Standard)

CARPET



Light Gray (Standard)
Ex-dono Quartet #393330
Fletco Carpets

FRAME



White (Standard)
F6463 Formica



Black
F2253 Formica

TABLE



White (Standard)
White laminate

SEATING FABRIC



Clint Gray (Standard)
Fiord 2 #151 Kvadrat



Clint Lemon (Standard)
Steelcut Trio



Grape
Select #61190 Gabriel



Rose
Select #65117 Gabriel



Green
Selected #68209 Gabriel



Antimicrobial Highland
Graphite 954 Panaz



Graphite
Select #60051 Gabriel



Dark Blue
Select #66144 Gabriel



Powder Blue
Select #67098 Gabriel



Beige
Select #61184 Gabriel



Mustard
Select #62098 Gabriel

Framery 2Q / Functionalities



CONTROL PANEL allows you to adjust ventilation and lighting inside the pod. It is a standard functionality included with all Framery 2Q configurations. For Framery 2Q Huddle and Lounge the control panel is installed on doorway frame; In Framery 2Q Without Furniture the control panel is in the middle column next to back glass.



SELF-CLOSING HINGES are used to make sure the door is not blocking passageways. Available for left-handed door. Includes set of black hinges for the door. Self-closing hinges are included as standard on all Framery 2Q configurations.

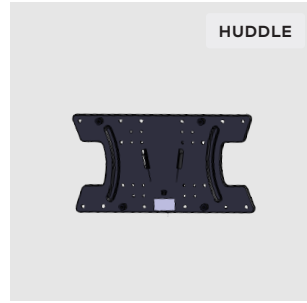

SCREEN BRACKET is located on the table wall. It is possible also to mount the bracket on the opposite wall. Option includes mounting plate for the wall, and mounting plate for the screen. Included in Framery 2Q Huddle. As an option, compatible with Framery 2Q Lounge and Without Furniture. Screen is not included.



POWER OUTLETS IN HUDDLE are installed as peak socket on Huddle table. It includes four power sockets, USB (C+A) and a HDMI socket. Additionally, two power sockets under the table. Optional LAN ports are available (replaces one of the power sockets). Included in Framery 2Q Huddle.

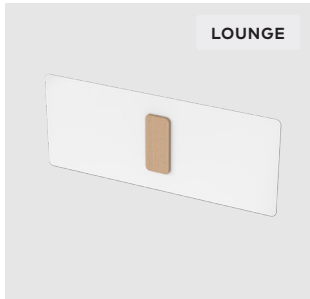

WHITEBOARD is attached to either side of the non-glass walls. Dimensions of the whiteboard are 100 x 240 cm / 39.4 x 93.6 in (height, width). Option includes the whiteboard and the cork center. Included in Framery 2Q Lounge. Compatible also with Framery 2Q Huddle and Without Furniture.



PIAGGIO TABLE is a movable table with tabletop dimensions of 36 x 42 cm / 14.1 x 16.5 in. Table height: 62 / 24.4 in. One Piaggio table is included in Framery 2Q Lounge. As an option, additional tables can be selected. Compatible also with Framery 2Q Without Furniture.

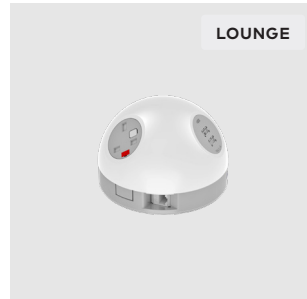

POWER OUTLETS IN LOUNGE are located under the lounge shelf table and the sofa. There are six power and two charging USB (C+A) sockets. Optional LAN ports are available. Included in Framery 2Q Lounge.



BOOKING BRACKET is a universal booking tablet bracket with a plywood surface attached to the door locking plate. Two sizes available to fit your device. Option includes the bracket and kit required for attachment. Customer acquires the booking tablet and cover for it which is mounted to the bracket. Bracket dimensions: Small 12 x 23 cm / 4.7 x 9.1 in. Large 22 x 30 cm / 8.7 x 11.8 in. Compatible with all Framery 2Q configurations.

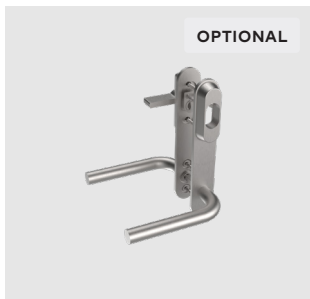

SMART LOCK COMPATIBLE is a kit of parts that allows customer selected smart lock and key to be installed. Option includes kit shown in picture. Smart lock itself is acquired by the customer. Compatible with all configurations of Framery 2Q.

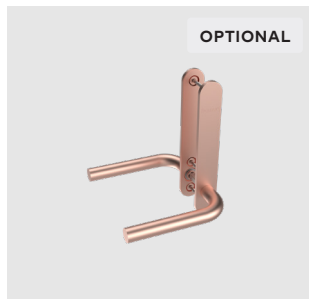

COPPER-PLATED DOOR HANDLE helps to prevent the spread of viruses. According to a study by Centers for Disease Control and Prevention (CDC), viruses disintegrate quicker after landing on copper surfaces than on plastic or stainless steel surfaces. Option includes copper-plated door handle. Compatible with all configurations of Framery 2Q.

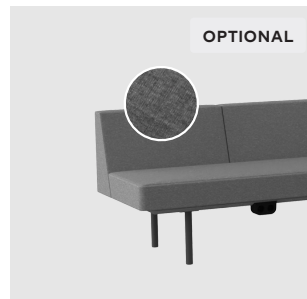

ANTI-MICROBIAL POLYESTER FABRIC is an anti-microbial, waterproof, bleach cleanable, stain resistant and durable polyester fabric. Our non-toxic material is safe and ISO 10993-5:2009 tested. Compatible with all configurations of Framery 2Q.

Framery 2Q

TECHNICAL SPECIFICATIONS

Size	EXTERIOR 222 x 235 x 280 cm / 87.4 x 92.5 x 110.2 in (h, w, d).
Weight	950 kg / 2094 lb (without furniture).
Ventilation Space	Min. recommended space for air to circulate: <ul style="list-style-type: none"> Above: 15 cm / 5.9 in.
Acoustics	29dB (Speech level reduction according to ISO-23351-1 testing method).
Airflow	Total airflow is 121 l/s, 256 CFM (436 m ³ /h). On standby mode the fans are working on 25 % of the maximum power.
Lighting	LED-Light 4000 K and 400 lux
Exterior materials	EXTERIOR Painted sheet metal. GLASS Sound control laminated glass (5+5 mm / 0.16+0.16in). FRAME Formica laminate on birch plywood with varnish trim.
Interior materials	SOLID WALLS AND ROOF A sandwich element of sheet metal, birch plywood, recycled acoustic foam and acoustic felt. FLOOR An anti-static and stain resistant low loop pile carpet. TABLE Formica laminate on birch plywood with varnish trim.

DIMENSIONS

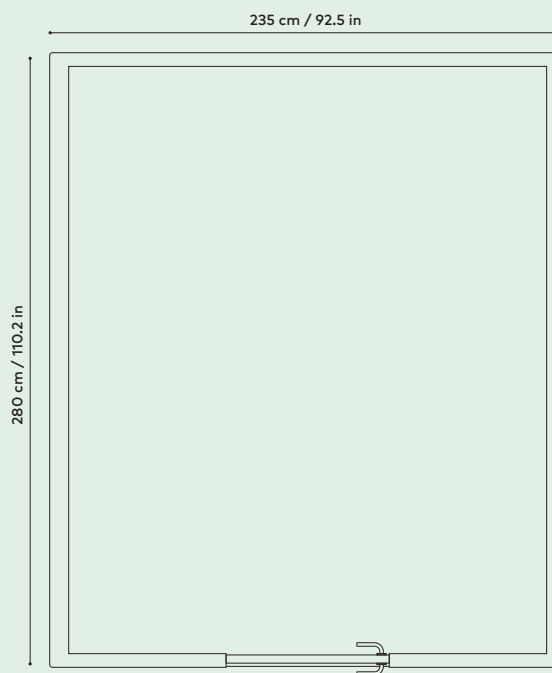
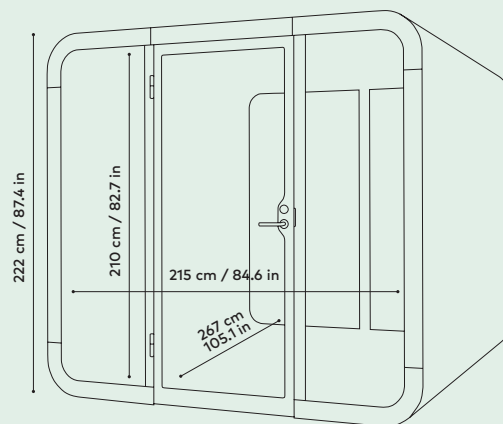

Framery 2Q is
UL GREENGUARD certified



Framery 2Q shipped in North
America is UL 962 listed

Framery 2Q Huddle

TECHNICAL SPECIFICATIONS

Size	EXTERIOR 222 × 235 × 280 cm / 87.4 × 92.4 × 110.2 in (h,w,d). INTERIOR 210 × 215 × 267 cm / 81.6 in × 84.6 × 105.1 in (h,w,d). DOORWAY 86 cm / 33.6 in wide.
Lighting	Led light: 4000 K and 400 lux.
Ventilation space	Min. recommended space for air to circulate: <ul style="list-style-type: none"> Sides: 15 cm / 5.9 in.
Power consumption	WHILE IN USE 42 W on standard configuration. Standard configuration: <ul style="list-style-type: none"> LED lights: 24 W. Fans in total: 18 W. STANDBY MODE 5 W. Input 100–240 VAC, 8.0 A, 50–60 Hz.
Huddle Table	140 × 86 cm / 54 × 33.6 in (l, w). Working height options 72 cm / 28.3 in and 110 cm / 43.3 in.
Outlets	On table 4 power sockets, USB-A+C, HDMI. Optional LAN (replaces 1 power socket). Under table 2 power sockets.
Output values	Output AC (power socket) 100–240VAC, 6.6A, 50–60 Hz. Output USB (TUF) charging Maximum combined output of 5 A at 5 VDC (25 W).
Screen specifications	Display bracket on the table wall. Possibility to mount a display on the opposite wall. Screen not included. Maximum display size 50". Maximum weight 30 kg / 66 lbs. VESA support 100×100, 100×150, 150 × 100, 200 × 100, 100 × 200, 200 × 200, 300 × 200, 400 × 200. Power cord can be led out of the bottom from backside of the pod, the length is 3.5m / 136.8 in. All electric components can be changed if there is a malfunction. Power consumption is a constant value that is determined by the power usage of the pods' internal components (electric unit, motion detector, light and fans). Framery's products can be plugged into a wall socket. The pods have their own power supplies that give 24 V DC to the lights and 12 V DC to the fans. The lights and fans are operated by a motion detector. Inside the pods, there are country-specific power outlets for charging mobile devices.

DIMENSIONS

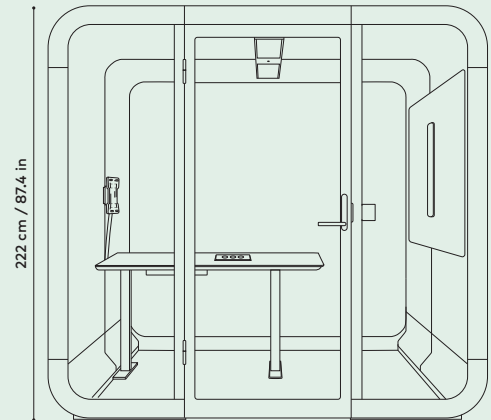

235 cm / 92.5 in

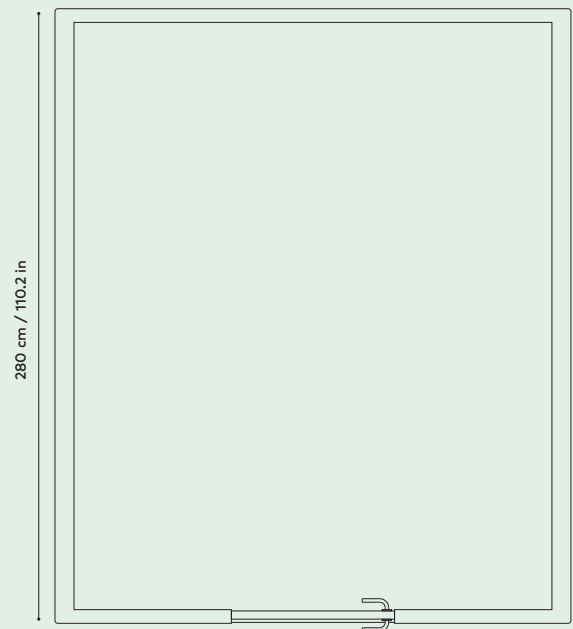

Framery 2Q Lounge

TECHNICAL SPECIFICATIONS

Size	EXTERIOR 222 × 235 × 280 cm / 87.4 × 92.4 × 110.2 in (h,w,d). INTERIOR 210 × 215 × 267 cm / 81.6 × 84.6 × 105.1 in (h, w, d). DOORWAY 86 cm / 33.6 in wide.
Lighting	Led light: 4000 K and 400 lux.
Ventilation space	Min. recommended space for air to circulate: <ul style="list-style-type: none">• Above: 15 cm / 5.9 in.
Power consumption	WHILE IN USE 42 W on standard configuration. Standard configuration: <ul style="list-style-type: none">• LED lights: 24 W.• Fans in total: 18 W. STANDBY MODE 5 W. Input 100–240 VAC, 8.0 A, 50–60 Hz.
Lounge wall shelf	175 cm / 68.4 in (length).
Lounge Piaggio table	62 × 42 × 36 cm / 24.4 × 16.5 × 14.1 in (h, w, d).
Outlets	6 power sockets, 2 USB-A+C, Optional Data Cartridge with 2 LAN ports.
Whiteboard	240 × 100 cm / 93.6 × 39.4 in (w, h).
Output values	Output AC (power socket) 100–240VAC, 6.6A, 50–60 Hz. Output USB (TUF) charging: Maximum combined output of 5 A at 5 VDC (25 W).
Screen specifications	Located on the centre of the lounge whiteboard. Screen not included. Maximum display size 50". Maximum weight 30 kg / 66 lbs. Tilting angle +5/-8°. VESA support 100 × 100, 100 × 150, 150 × 100, 200 × 100, 100 × 200, 200 × 200, 300 × 200, 400 × 200. Power cord can be led out of the bottom from backside of the pod, the length is 3.5m / 136.8 in. All electric components can be changed if there is a malfunction. Power consumption is a constant value that is determined by the power usage of the pods' internal components (electric unit, motion detector, light and fans). Framery's products can be plugged into a wall socket. The pods have their own power supplies that give 24 V DC to the lights and 12 V DC to the fans. The lights and fans are operated by a motion detector. Inside the pods, there are country-specific power outlets for charging mobile devices.

DIMENSIONS

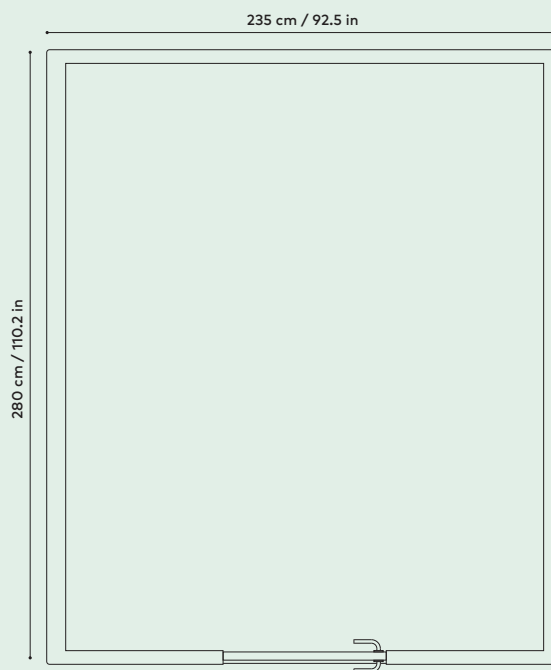
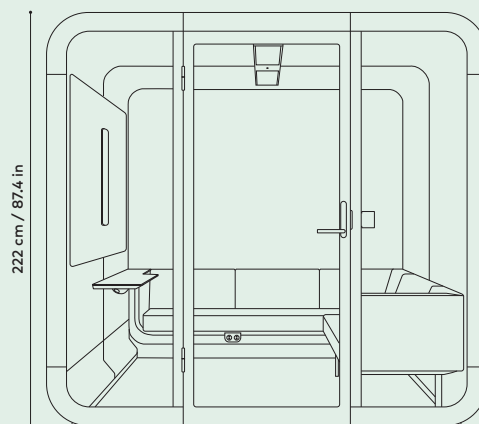

Framery 2Q Without furniture

TECHNICAL SPECIFICATIONS

Size	EXTERIOR 222 × 235 × 280 cm / 87.4 × 92.4 × 110.2 in (h,w,d). INTERIOR 210 × 215 × 267 cm / 81.6 × 84.6 × 105.1 in (h,w,d). DOORWAY 86 cm / 33.6 in wide.
Lighting	Led light: 4000 K and 400 lux.
Ventilation space	Min. recommended space for air to circulate: <ul style="list-style-type: none">• Sides: 5 cm / 1.9 in.
Power consumption	WHILE IN USE 42 W on standard configuration. Standard configuration: <ul style="list-style-type: none">• LED lights: 24 W.• Fans in total: 18 W. STANDBY MODE 5 W. Input 100–240 VAC, 8.0 A, 50–60 Hz.
Outlets	3 power sockets, USB-A+C, Optional: LAN (replaces 1 power socket).
Output values	Output AC (power socket) 100–240 VAC, 6.6A, 50–60 Hz. Output USB (TUF) charging: Maximum combined output of 5 A at 5 VDC (25 W). Power cord can be led out of the bottom from backside of the pod, the length is 3.5m / 136.8 in.

All electric components can be changed if there is a malfunction. Power consumption is a constant value that is determined by the power usage of the pods' internal components (electric unit, motion detector, light and fans). Framery's products can be plugged into a wall socket. The pods have their own power supplies that give 24 V DC to the lights and 12 V DC to the fans. The lights and fans are operated by a motion detector. Inside the pods, there are country-specific power outlets for charging mobile devices.

DIMENSIONS

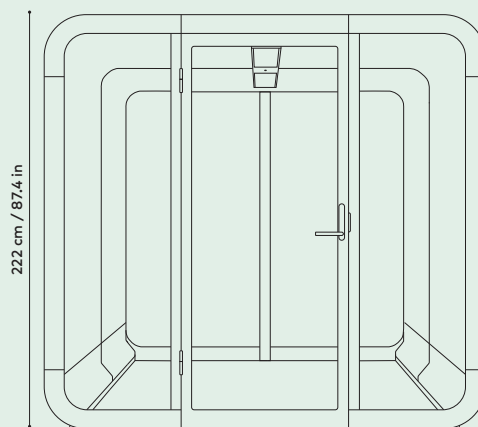

235 cm / 92.5 in

