

---

# BuzziScreen

## Product Specification Sheet

---

This document contains technical information about the BuzziScreen

---



[www.buzzi.space](http://www.buzzi.space)



## Sound absorbing dividing screen

The folding screen has come back into fashion with a bang!

The BuzziScreen is a contemporary take on the flexible room divider with all sorts of advantages.

For example, it can be extended infinitely: the handy recycled zipper system makes it easy for you to add panels. Just like with other BuzziSpace products, you can pin objects, photos or letters to the screen, and of course it works as sound absorption as well. Divide your office or room however you want, wherever you want!

Design by Sas Adriaenssens

---

## General

📏 S | M | L

Cover: BuzziFelt

🌲 Core: honeycomb cardboard  
Zipper in orange or black

☁️ Dry use

🔧 Flat packed

Bicolor

⋮ BuzziFoot: extra support in powder coated metal black (RAL 9005) or alu color (RAL 9006)  
Extra layer in Fabric, Trevira CS+ | CS, Revive 1, Clara 2, Remix 3, Hero, Tonus 4, Memory 2

---

## Certifications



---

## Acoustics



Absorption



Diffusion



Attenuation



Mid tone



High tone

---

## Content

Configurations	3	Fabrics	6
Panels	4	Dimensions	10
Combinations: examples	5	Acoustics	11

# Configurations

---

## BuzziScreen

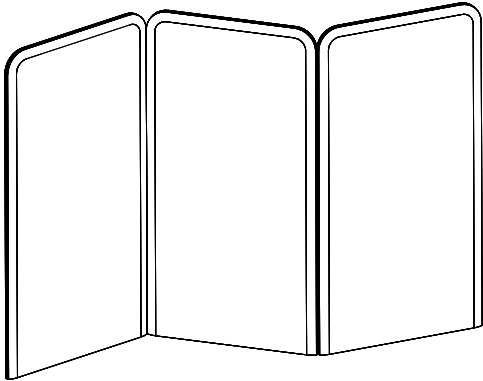

◆ S | M | L

Cover: BuzziFelt

🌲 Core: honeycomb cardboard  
Zipper in orange or black

S: H 120 cm    W 80 cm  
    H 47.24"    W 31.50"

✂ M: H 150 cm    W 80 cm  
    H 59.06"    W 31.50"

L: H 200 cm    W 80 cm  
    H 78.74"    W 31.50"

⚖ S: 4,2 kg  
    9.26 lbs

M: 5 kg  
    11.02 lbs

L: 6,3 kg  
    13.89 lbs

Bicolor

◆◆◆ BuzziFoot: extra support in powder coated metal black (RAL 9005) or alu (RAL 9006)

Extra layer in Fabric, Trevira CS+ | CS, Revive 1, Clara 2, Remix 3, Hero, Tonus 4, Memory 2

# Panels

---

Puller Side

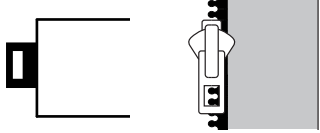

Pin Side



Label (only with Stop panel)

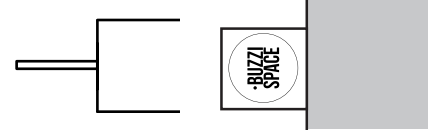

1-Stop panel

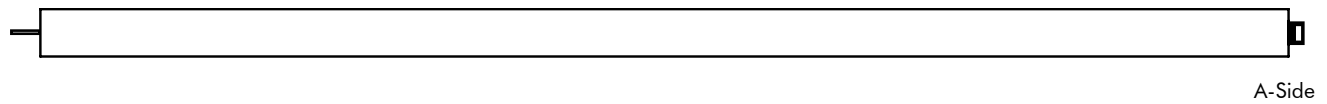

2-Start panel

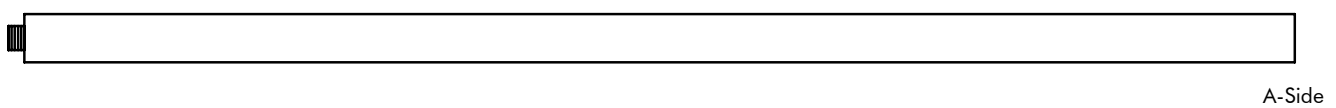

3-Mid panel

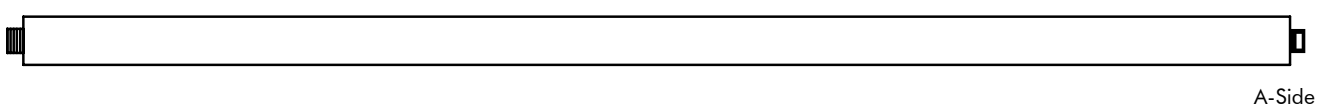

4-Stop extra panel

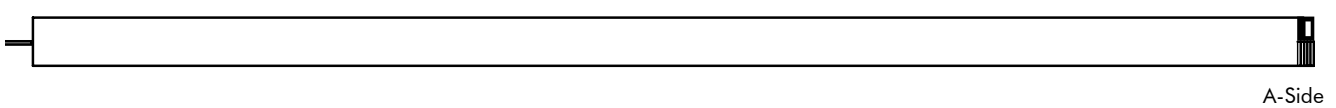

5-Start extra panel

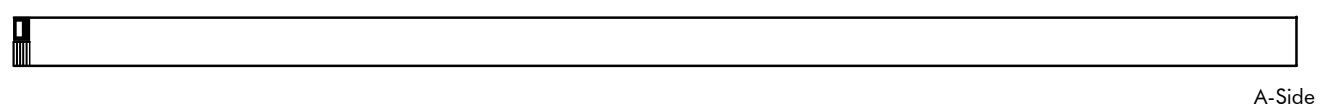

6-Mid extra R panel

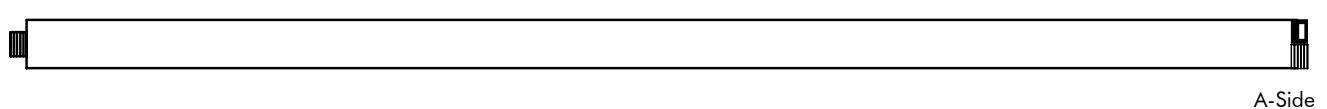

7-Mid extra L panel

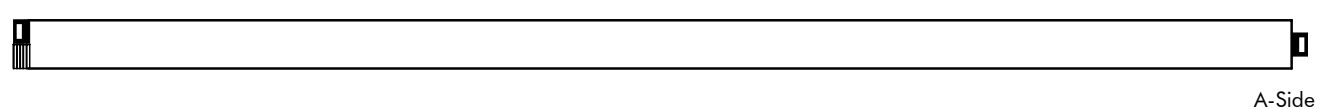

8-Mid extra plus panel

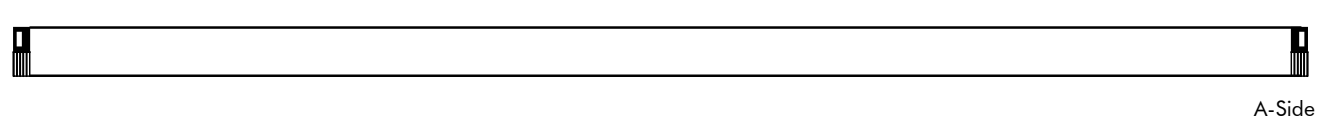

# Combinations: examples

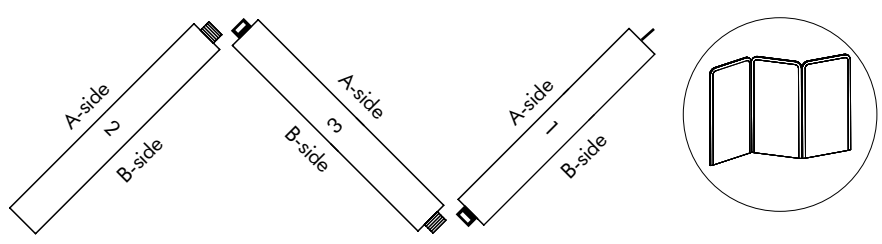
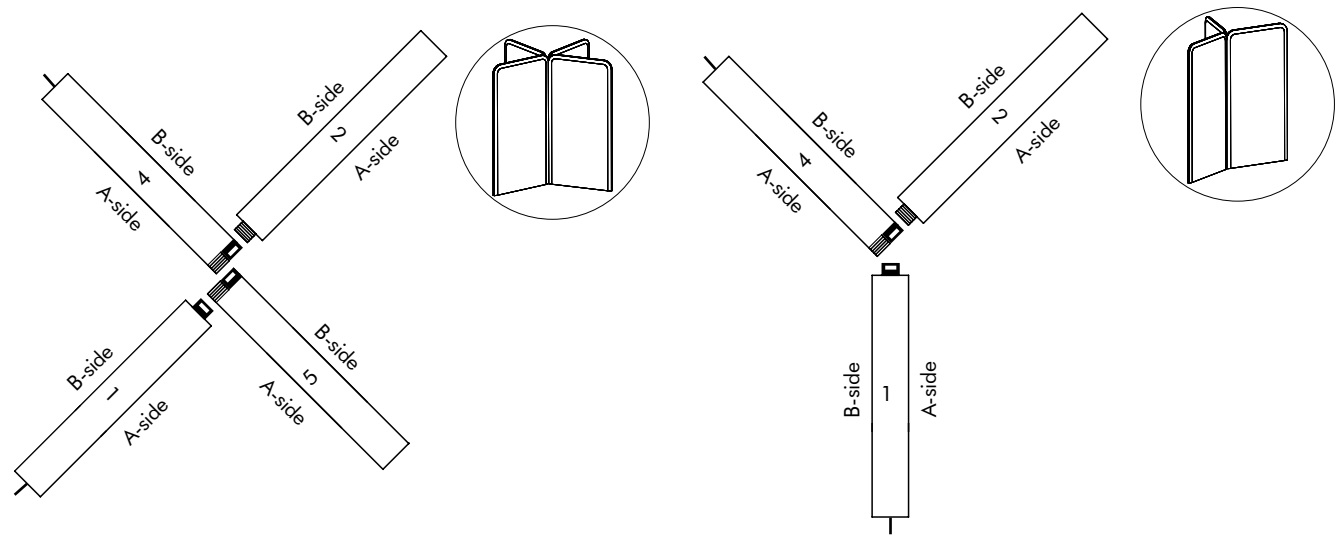
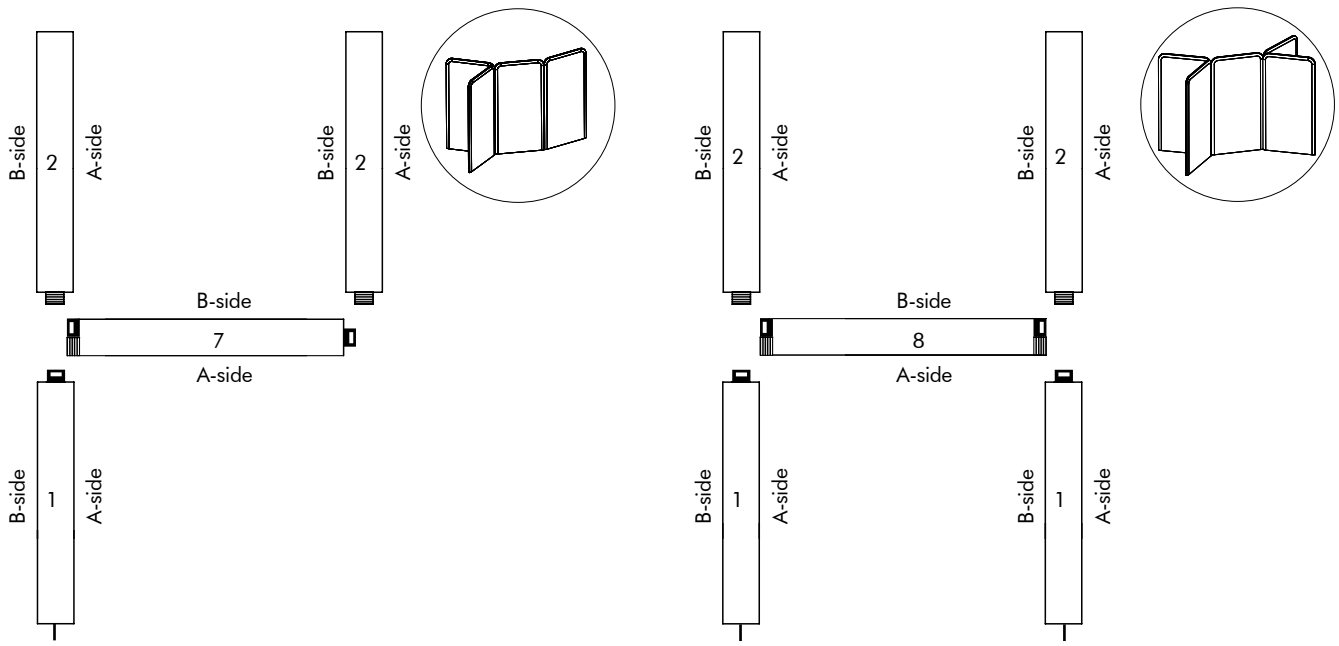

It's not recommended to put several BuzziScreens in one straight line (go zigzag!)

# Fabric

## Felt

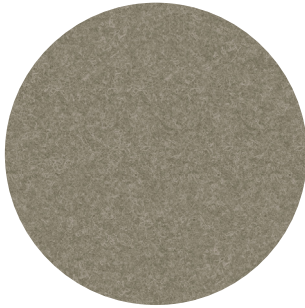

**Composition** 100% Recycled PE.T. Felt, latex backing  
**Weight** 1.000 g/m<sup>2</sup> | 29.49 oz/yd<sup>2</sup>  
**Abrasion resistance** >7.000 Martindale  
**Flammability** EU: EN 13501.1 + A1/2009 Class B-s1,d0  
USA: ASTM E84 Class A certified  
**Fastness to light** USA 5



## Fabric

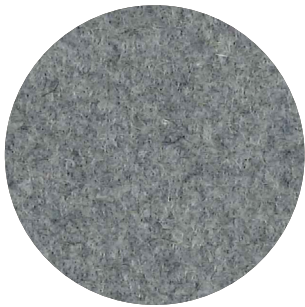

**Category** A  
**Composition** 70% Recycled Wool, 25% Recycled Polyacryl,  
5% Recycled Other Fabrics  
**Weight** 405 g/m<sup>2</sup> | 11.94 oz/yd<sup>2</sup>  
**Abrasion resistance** 40.000 Martindale, 50,000 Wyzenbeek  
**Flammability** EU: EN 1021.1/2006 | BS EN 1021.1/2006 (cigarette).  
EN 1021.2/2006 | BS EN 1021.2/2006 (match)  
USA: CAL TB 117 | ASTM E84 CLASS A  
**Fastness to light** EU: 4 | USA 4  
**Fastness to rubbing** EU: Wet 3-4 | Dry 4-5  
**Fastness to crocking** USA: Wet 5 | Dry 5



## Trevira CS+ | CS

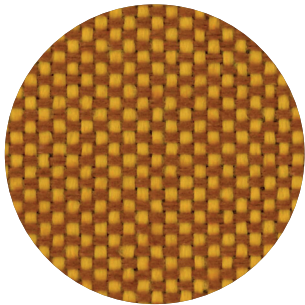

**Category** A  
**Weight** 420 g/m<sup>2</sup> | 12.39 oz/yd<sup>2</sup>  
**Composition** 100% Polyester, Trevira CS  
**Abrasion resistance** 100.000 Martindale, 90,000 Wyzenbeek  
**Flammability** BS 5852 part II: CRIB 5 | BS 7176 Medium Hazard  
USA: CAL TB 117 | M1 | B1 | EN 1021/1-2 | C1 |  
IMO Res. A652 (16)  
**Fastness to light** EU: 6 | USA 5  
**Fastness to rubbing** EU: Wet 4-5 | Dry 4-5  
**Fastness to crocking** USA: Wet 5 | Dry 5



## Revive 1

kvadrat

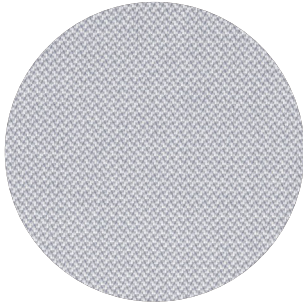

**Category A**

**Composition** 100% recycled polyester FR

**Weight** 430 g/lin.m

**Abrasion resistance** 60.000 Martindale rubs, EN ISO 12947

**Flammability** EN 1021-1/2 | DIN 4102 B1 | Önorm B1/Q1  
UNI 9175 1IM | US Cal. Tech. Bull. 117  
IMO A.652 (16)

**Fastness to light** Note 5-7, ISO 105-B02

**Fastness to rubbing** (ISO) dry 5, wet 4-5

**Pilling** Note 4-5, EN ISO 12945



## Clara 2

kvadrat

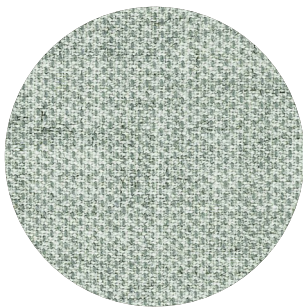

**Category B**

**Composition** 92% new wool, 8% nylon

**Weight** 400 g/lin.m

**Abrasion resistance** 80.000 Martindale rubs, EN ISO 12947

**Flammability** EN 1021-1/2 | BS 5852, ignition source 2-3 | DIN 4102 B2  
NF D 60 013 | UNI 9175 1IM | US Cal. Tech. Bull. 117, Sec. E  
NFPA 260 | IMO A.652(16)

**Fastness to light** Note 5-7, ISO 105-B02

**Fastness to rubbing** (ISO) dry 4-5, wet 4

**Pilling** Note 4, EN ISO 12945



## Remix 3

kvadrat



**Category B**

**Composition** 90% new wool, 10% nylon

**Weight** 415 g/lin.m

**Abrasion resistance** 100.000 Martindale rubs, EN ISO 12947

**Flammability** EN 1021-1/2 | BS 5852 part 1  
Önorm B1/Q1 | NF D 60 013 | UNI 9175, 1IM  
AS/NZS 1530.3 | Cal. Tech. Bull. 117-2013  
NFPA 260 | IMO FTP Code 2010:Part 8

**Fastness to light** Note 5-7, ISO 105-B02

**Fastness to rubbing** (ISO) dry 4-5, wet 4

**Pilling** Note 4, EN ISO 12945



## Hero

kvadrat

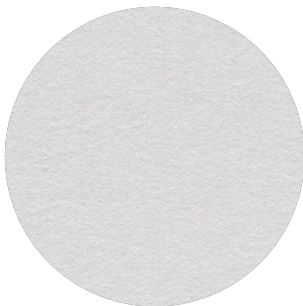

**Category C**

**Composition** 96% new wool, 4% nylon

**Weight** 580 g/lin.m

**Abrasion resistance** 45.000 Martindale rubs, EN ISO 12947

**Flammability** EN 1021-1/2 | DIN 4102 B2 | NF D 60 013  
UNI 9175 1IM | US Cal. Tech. Bull. 117-2013 | NFPA 260  
IMO A.652 (16)

**Fastness to light** Note 5-6, ISO 105-B02

**Fastness to rubbing** (ISO) dry 4-5, wet 4-5

**Pilling** Note 3-4, EN ISO 12945



## Tonus 4

kvadrat



**Category** D

**Composition** 90% new wool, 10% Helanca

**Weight** 665 g/lin.m

**Abrasion resistance** 100.000 Martindale rubs, EN ISO 12947

**Flammability** EN 1021-1/2 | BS 5852 part 1 | DIN 4102 B2

Önorm B1/Q1 | NF D 60 013 | UNI 9175 11M

US Cal. Bull. 117-2013 | NFPA 260 | IMO A.652 (16)

**Fastness to light** Note 5-7, ISO 105-B02

**Fastness to rubbing** (ISO) dry 3-5, wet 3-5

**Pilling** Note 3, EN ISO 12945



## Memory 2

kvadrat

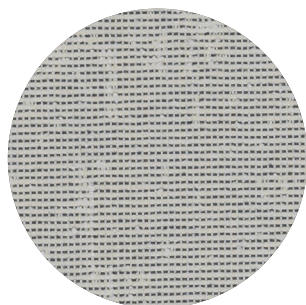

**Category** E

**Composition** 100% Trevira CS

**Weight** 700 g/lin.m

**Abrasion resistance**

35.000 rubs acc. to the Martindale method, EN ISO 12947

**Flammability** EN 1021-1/2 | DIN 4102 B1 | Önorm B1/Q1

NF D 60 013 | NF P 92 507 M1 | UNI 9175 11M

UNI 9177 classe 1 | US Cal. Tech. Bull. 117

IMO A.652 (16)

**Fastness to light** Note 5-8, ISO 105-B02

**Fastness to rubbing** (ISO) dry 4-5, wet 4-5

**Pilling** Note 4, EN ISO 12945



---

## Felt Printed\*



Concrete

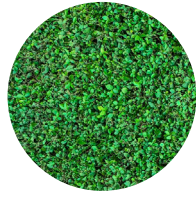

Green 1



Green 2



Jungle

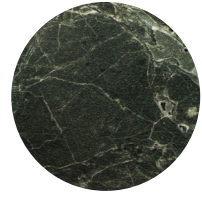

Marble Absynth

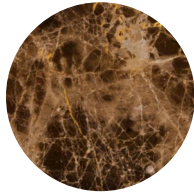

Marble Emperador



Camo Amazon



Camo Taiga



Camo Desert



Camo Snow

\*Same Specifications as Felt

# Dimensions

## BuzziScreen

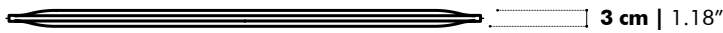
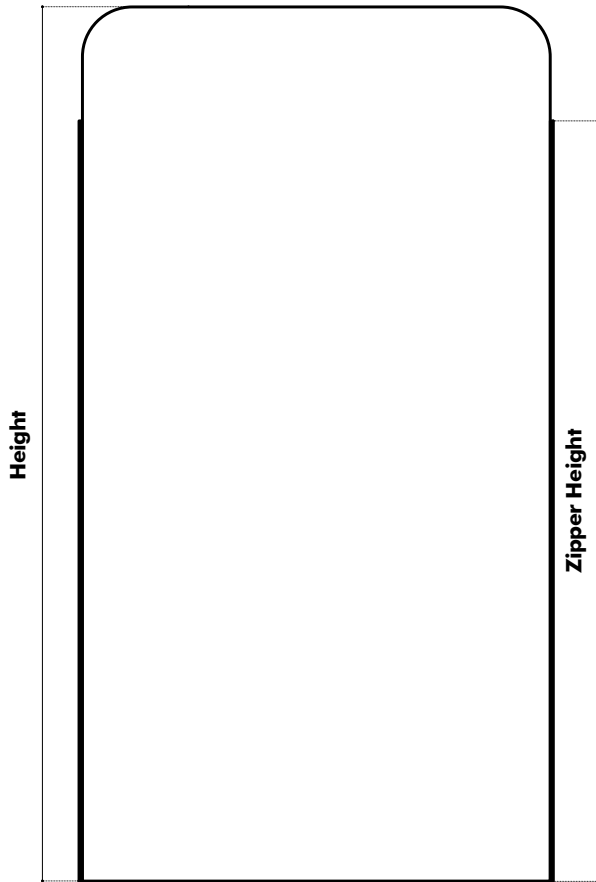

## BuzziFoot

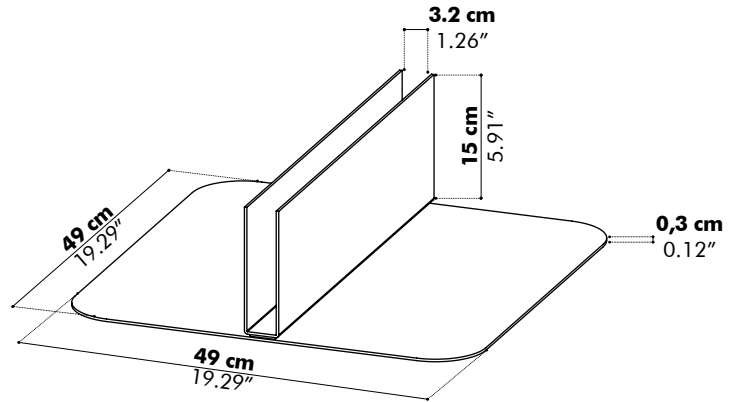

## BuzziScreen

	Height		Zipper Height	
<b>S</b>	<b>120 cm</b>	47.24"	<b>100 cm</b>	39.37"
<b>M</b>	<b>150 cm</b>	59.06"	<b>130 cm</b>	51.18"
<b>L</b>	<b>200 cm</b>	78.74"	<b>180 cm</b>	70.87"

# Acoustics

## Equivalent sound absorption area in m<sup>2</sup> per object

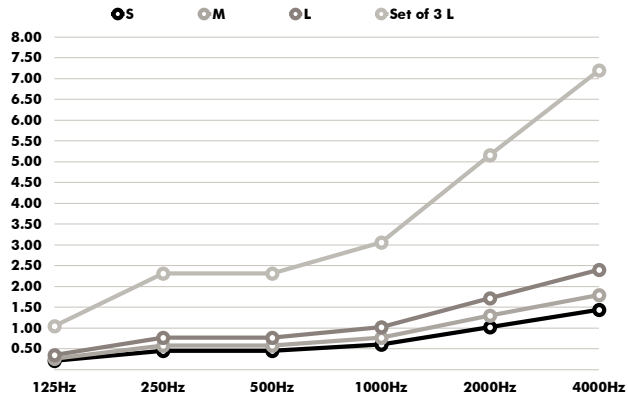

Hz	S Aeq/m <sup>2</sup>	M Aeq/m <sup>2</sup>	L Aeq/m <sup>2</sup>	Set of 3 L Aeq/m <sup>2</sup>
125	0.21	0.26	0.35	1.05
250	0.46	0.58	0.77	2.31
500	0.46	0.58	0.77	2.31
1000	0.61	0.77	1.02	3.06
2000	1.03	1.30	1.72	5.16
4000	1.44	1.80	2.40	7.20